

audio  
automotive  
aerospace  
communication devices  
consumer appliances  
consumer electronics  
datacom  
data storage  
handheld devices  
industrial  
industrial equipment  
instrumentation  
medical  
military  
mobile phones  
portable tools  
pumps & motors  
security

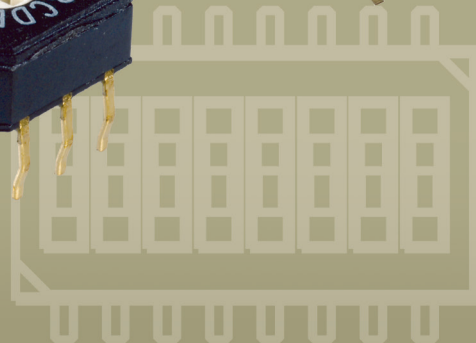

# DIP

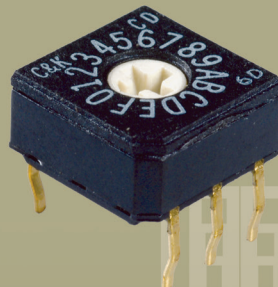

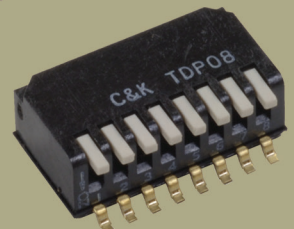
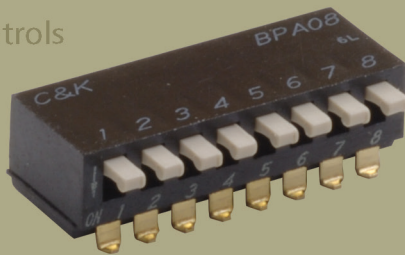
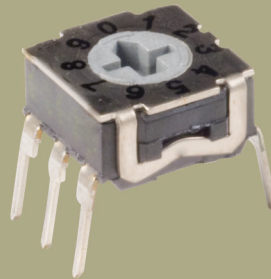
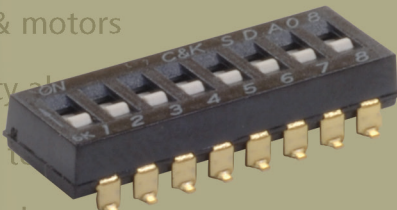
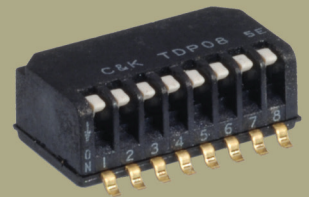
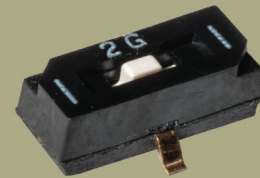
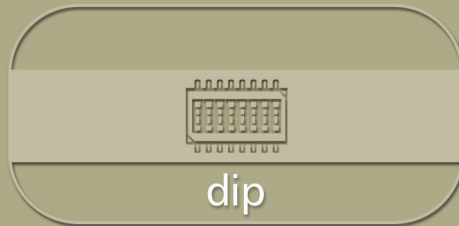

thermostatic controls  
test equipment





# DIP

## Product Selection Guide

PRODUCT LINE

DIP H

DIP					
Series	TDP	TDA	SDA	SD	BD
Switch Type	Half-pitch .050" Side actuated	Half-pitch .050"	Low Profile	Low Profile	Standard Profile
No. of Positions	2-10 (even only)	1 & 2-10 (even only)	1-12 (except 11)	2-12 (except 11)	1-12 (except 11)
Contact Style	SPST	SPST	SPST	SPST	SPST
Profile off PCB	.173 (4,4)	.087 (2,2)	.189 (4,80) Thru-hole .177 (4,5) SMT	.168 (4,27) Thru-hole .160 (4,06) SMT	.297 (7,55) Vertical .380 (9,65) Rt. Angle
Process Sealed	Washable with tape seal	Washable with tape seal	Washable (tape not required)	Washable with tape seal	Washable (tape not required)
Extended Actuator	•		•	•	•
Flush Actuator	•	•	•	•	
Thru-hole			•	•	•
Vertical		•	•	•	•
Right Angle	•				•
Surface Mount	•	•	•	•	
Tape & Reel (SMT only)	•	•	•	•	
Maximum Current	100mA	100mA	100mA	100mA	100mA
Page No.	H-5	H-8	H-11	H-15	H-18

					
Series	BPA	TDD	SPA	RTE	RTF
Switch Type	Side actuated	Jumper Switch	Single In-line Package	Rotary & Coded	Rotary & Coded
No. of Positions	1-12 (except 11)	1	2-10 (even only)	1, 10, 16	4, 10, 16
Contact Style	SPST	SPDT	SPST	Coded	Coded
Profile off PCB	.287 (7,3) Thru-hole .277 (7,04) SMT	.090 (2,3)	.244 (6,2) Vertical .169 (4,3) Rt. Angle	.167 (4,25) Thru-hole .335 (8,5) Rt. angle	See Datasheet
Process Sealed	Washable (tape not required)	Washable with tape seal	Washable (tape not required)	NA	IP67
Extended Actuator	•		•	•	•
Flush Actuator		•	•	•	•
Thru-hole	•			•	•
Vertical		•	•	•	•
Right Angle	•		•	•	•
Surface Mount	•	•	•	•	•
Tape & Reel (SMT only)	•	•	•	•	•
Maximum Current	100mA	100mA	10mA	100mA	100mA
Retention Feature			•	•	
Page No.	H-20	H-23	H-25	H-27	H-33



Dimensions are shown: Inch (mm)  
Specifications and dimensions subject to change

# DIP

## Product Selection Guide



H  
DIP

DIP			
Series	CD	CRD	CRE
Switch Type	8 mm Coded Rotary	10 mm Coded Rotary	10 mm Coded Rotary
No. of Positions	1, 10, 16	10, 16	4, 6, 8, 10, 16
Contact Style	Coded	Coded	Coded
Profile off PCB	.168 (4,27) Thru-hole .340 (8,6) Rt. angle	.272 (6,9) Vertical .414 (10.5) Rt. angle	Multiple heights available
Process Sealed	Washable (tape not required)	Washable (tape not required)	Washable (tape not required)
Extended Actuator		•	•
Flush Actuator	•	•	•
Thru-hole	•	•	•
Vertical	•	•	
Right Angle	•	•	
Surface Mount	•	•	•
Tape & Reel (SMT only)	•	•	•
Maximum Current	0.4VA	0.4VA	150 mA
Retention Feature	• C option		
Page No.	H-37	H-41	H-45

# TDP Series Ultra-miniature Surface Mount Half-pitch Side-Actuated DIP Switches



H  
DIP

## Features/Benefits

- World's first ultra-miniature SMT half-pitch side-actuated DIP
- Side actuation allows visual indication of on/off position in horizontal applications
- Process sealed for surface mount soldering and washable processing
- RoHS compliant
- Lead free

## Typical Applications

- Hand-held electronic devices
- Portable computer and electronic devices
- Instrumentation and controls



## Specifications

SWITCH FUNCTION: SPST — 2, 4, 6, 8, 10 positions.

CONTACT RATING:

24 V DC, 25 mA (switching).

50 V DC, 100 mA (steady state).

MECHANICAL AND ELECTRICAL LIFE: 1,000 cycles.

CONTACT RESISTANCE: 100 mΩ max.

INSULATION RESISTANCE: 100 MΩ @ 100 V DC min.

DIELECTRIC STRENGTH: 300 V AC min.

STORAGE TEMPERATURE: -40°C to 85°C.

OPERATING TEMPERATURE: -40°C to 85°C.

OPERATING FORCE: 4.9N max.

SOLDERABILITY: Per MIL-STD-202F method 208D, or

EIA RS-186E method 9 (1 hour steam aging).

PACKAGING: Switches supplied in rigid dispensing tubes in full tube quantities only, this may affect order quantity. Tape and reel packaging also available.

## Materials

CASE & COVER: glass filled PPS (UL94V-0).

ACTUATOR: PA6T (UL94V-0).

CONTACTS: Copper alloy with gold plate over nickel plate.

TERMINALS: Copper alloy, with gold over nickel plate.

All terminals are insert molded.

TAPE SEAL: Polyimide.

**Note:** Specifications and materials listed above are for switches with standard options. For information on specific and custom switches, consult Customer Service Center.

## How To Order

The Build-A Switch concept allows you to mix and match options to create the switch you need. Below is a complete listing of options shown in catalog. To order, simply select desired option from each category and place in the appropriate box.

All switches supplied in "OFF" position.

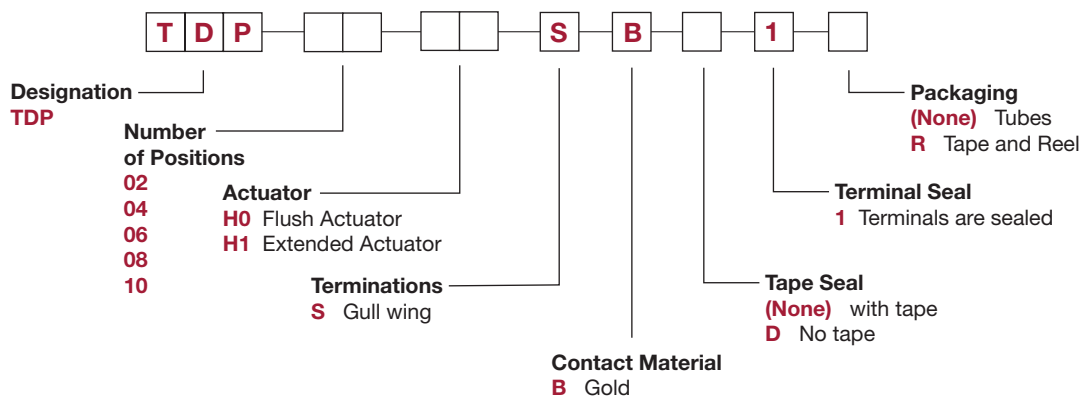

**Note:** Tape seal is not available with H1 Extended Actuators.



Dimensions are shown: Inch (mm)  
Specifications and dimensions subject to change



# TDP Series Ultra-miniature Surface Mount Half-pitch Side-Actuated DIP Switches

DIP H

## Flush Actuator-No Top Tape, Surface Mount Terminals

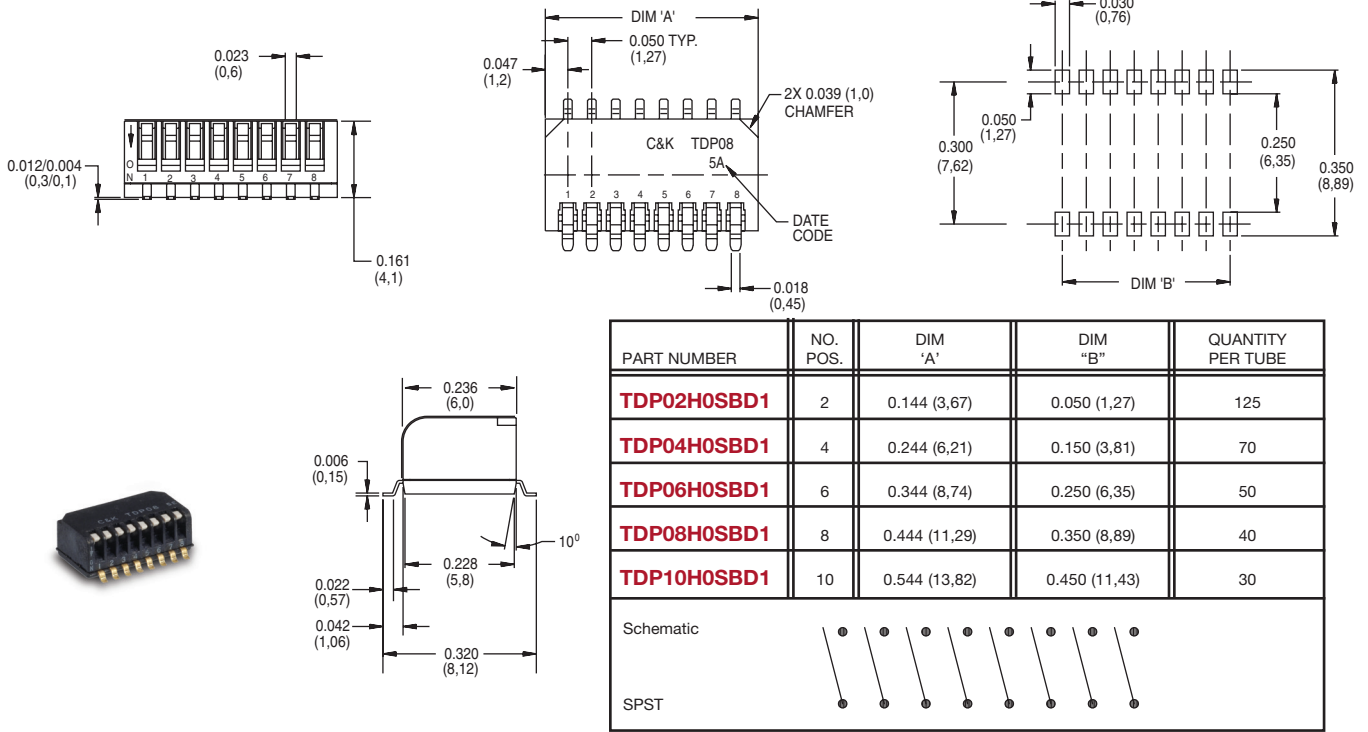

## Flush Actuator-with Top Tape, Surface Mount Terminals

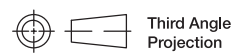
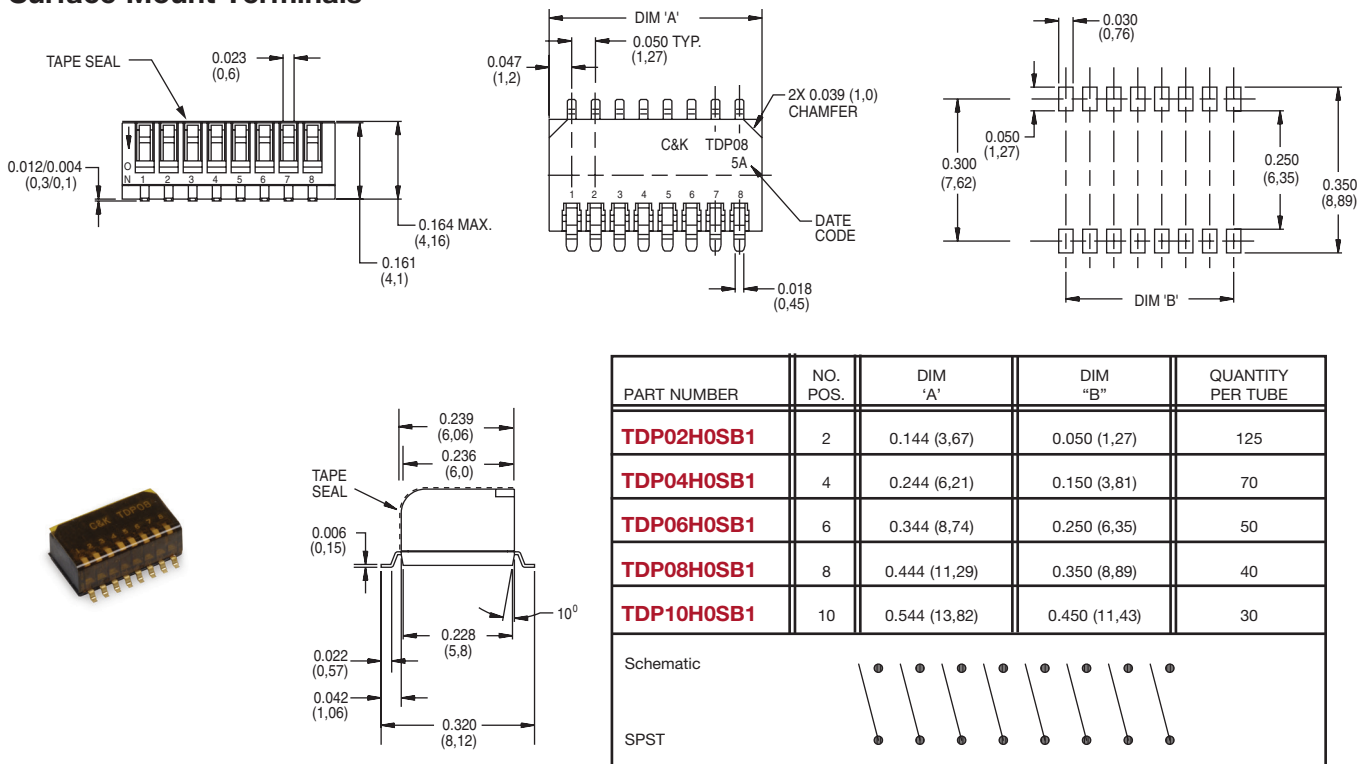

Dimensions are shown: Inch (mm)  
Specifications and dimensions subject to change



# TDP Series Ultra-miniature Surface Mount Half-pitch Side-Actuated DIP Switches



**H DIP**

## Extended Actuator-No Top Tape, Surface Mount Terminals

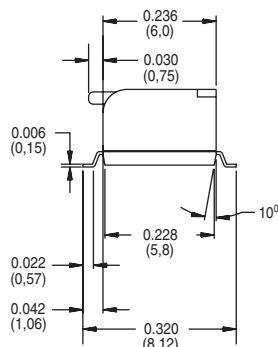
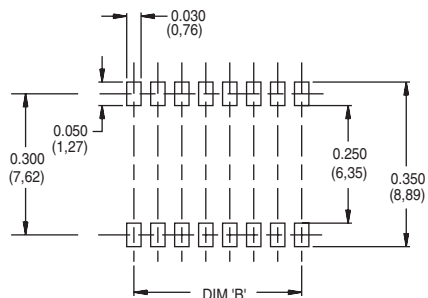
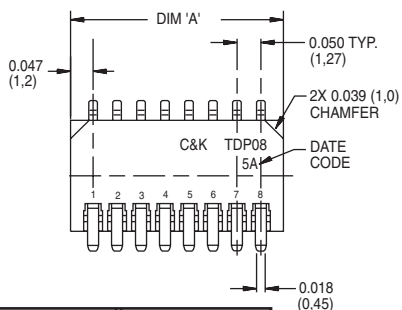
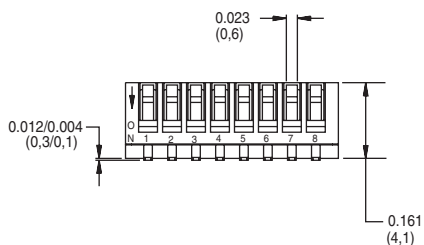

PART NUMBER	NO. POS.	DIM 'A'	DIM "B"	QUANTITY PER TUBE
<b>TDP02H1SBD1</b>	2	0.144 (3,67)	0.050 (1,27)	125
<b>TDP04H1SBD1</b>	4	0.244 (6,21)	0.150 (3,81)	70
<b>TDP06H1SBD1</b>	6	0.344 (8,74)	0.250 (6,35)	50
<b>TDP08H1SBD1</b>	8	0.444 (11,29)	0.350 (8,89)	40
<b>TDP10H1SBD1</b>	10	0.544 (13,82)	0.450 (11,43)	30

Schematic

SPST

## Tube Packaging

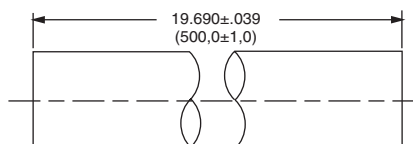
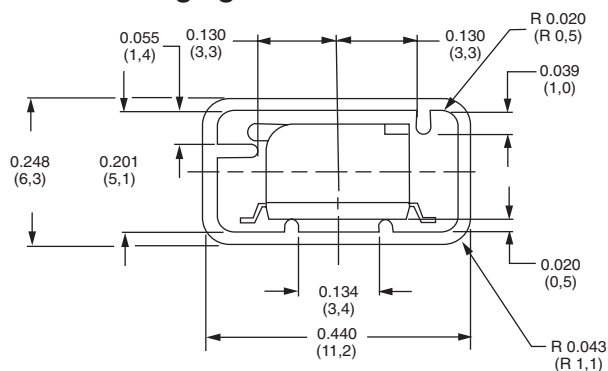

MODEL NUMBER	QTY IN TUBE
<b>TDP02</b>	125
<b>TDP04</b>	70
<b>TDP06</b>	50
<b>TDP08</b>	40
<b>TDP10</b>	30

Note: Switch shown has H1 extended actuator.

## Tape and Reel Packaging

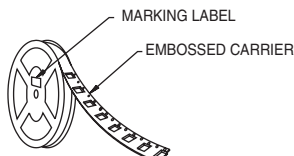

DIM PART NUMBER	DIM. "W"	DIM "P"	PER REEL
<b>TDP02</b>	0.630 (16,0)	0.175 (4,45)	1,000
<b>TDP04</b>	0.630 (16,0)	0.276 (7,0)	1,000
<b>TDP06</b>	0.630 (16,0)	0.376 (9,55)	1,000
<b>TDP08</b>	0.945 (24,0)	0.476 (12,1)	1,000
<b>TDP10</b>	0.945 (24,0)	0.576 (14,65)	1,000

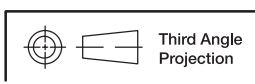
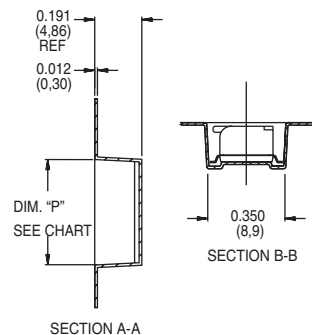
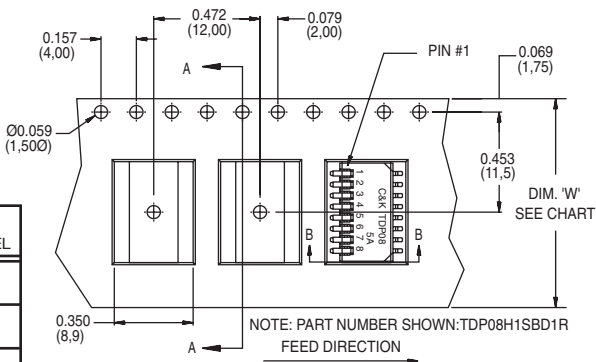

Dimensions are shown: Inch (mm)  
Specifications and dimensions subject to change



# TDA Series

## Ultra-miniature Surface Mount Half-pitch DIP Switches

DIP H

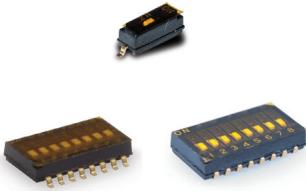

### Features/Benefits

- **Bifurcated contact for increased electrical reliability**
- **Process sealed for surface mount soldering and washable processing**
- **RoHS compliant**

### Typical Applications

- **Hand-held electronic devices**
- **Portable computer and electronic devices**
- **Instrumentation and controls**

### Specifications

SWITCH FUNCTION: SPST – 1, 2, 4, 6, 8 & 10 positions.

CONTACT RATING:

24 V DC, 25 mA (switching).

50 V DC, 100 mA (steady state).

MECHANICAL AND ELECTRICAL LIFE: 1,000 cycles.

CONTACT RESISTANCE: 100 mΩ max.

INSULATION RESISTANCE: 100 MΩ @ 100 V DC min.

DIELECTRIC STRENGTH: 300 V AC min.

STORAGE TEMPERATURE: -40°C to 85°C.

OPERATING TEMPERATURE: -40°C to 85°C.

OPERATING FORCE: 4,9N max.

SOLDERABILITY: Per MIL-STD-202F method 208D, or EIA RS-186E method 9 (1 hour steam aging).

PACKAGING: Switches supplied in rigid dispensing tubes in full tube quantities only, this may affect order quantity. Numbers of switches per tube varies with model. Tape and reel packaging quantity varies with model.

### Materials

CASE & COVER: PPS (UL94V-0)

ACTUATOR: LCP (UL94V-0).

CONTACTS: Copper alloy, with gold plate over nickel plate.

TERMINALS: Copper alloy, with gold flash over nickel plate.

All terminals are insert molded.

TAPE SEAL: Polyimide.

**Note:** Specifications and materials listed above are for switches with standard options. For information on specific and custom switches, consult Customer Service Center.

**Note:** All switches supplied in "OFF" position.

### How To Order

The Build-A Switch concept allows you to mix and match options to create the switch you need. Below is a complete listing of options shown in catalog. To order, simply select desired option from each category and place in the appropriate box.

All switches supplied in "OFF" position.

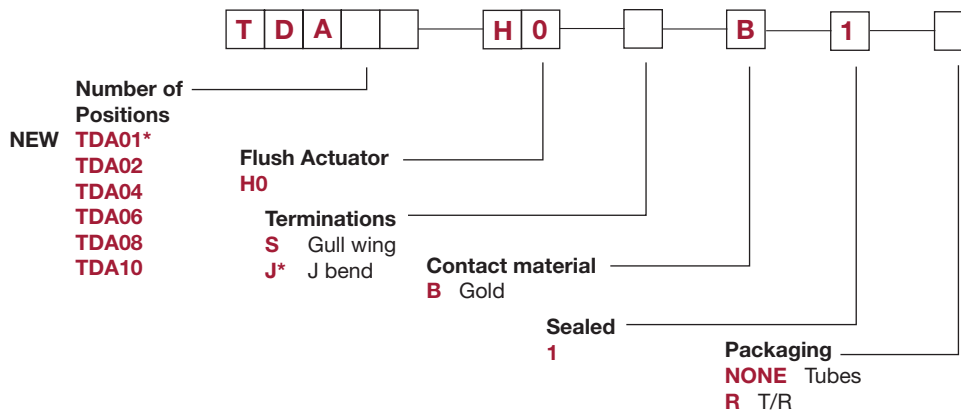

\* TDA01H0JB1R is not available, TDA01 only offered in tape & reel

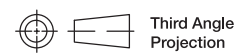

Dimensions are shown: mm  
 Specifications and dimensions subject to change



# TDA Series Ultra-miniature Surface Mount Half-pitch DIP Switches



**H  
DIP**



**TDA08H0SB1**

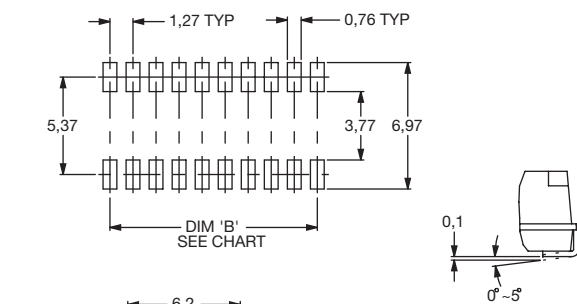
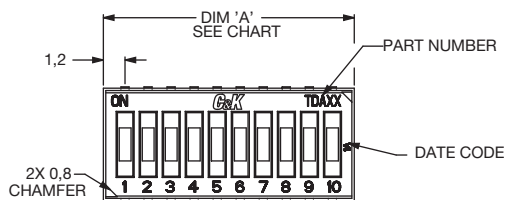
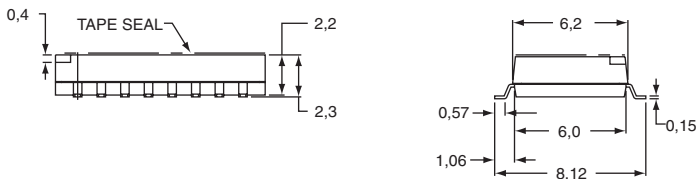
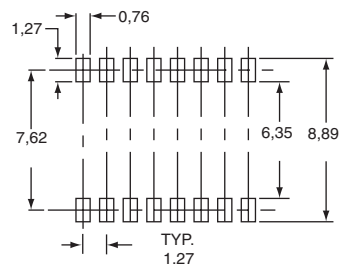
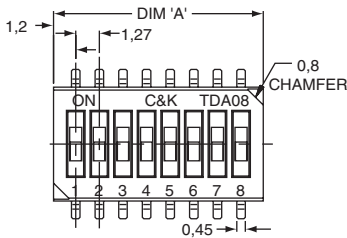

**TDA10H0JB1**

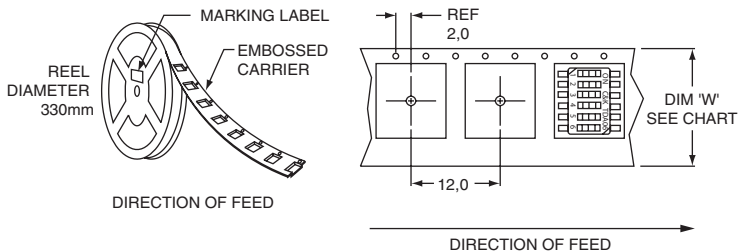
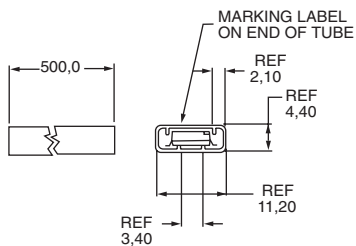
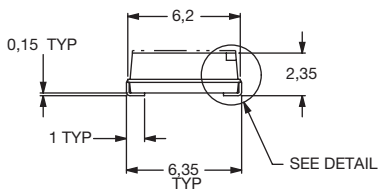
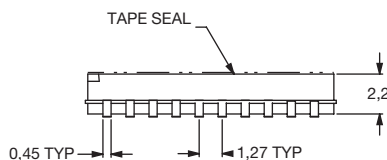

## Tube Package

ROHS PART NUMBER	NO. POS.	DIM. 'A'	DIM. 'B'	QUANTITY PER TUBE
<b>TDA01H0SB1</b>	1	2,40	NA	NA
<b>TDA02H0_B1</b>	2	3,67	1,27	125
<b>TDA04H0_B1</b>	4	6,21	3,81	70
<b>TDA06H0_B1</b>	6	8,75	6,35	50
<b>TDA08H0_B1</b>	8	11,29	8,89	40
<b>TDA10H0_B1</b>	10	13,83	11,43	30

Schematic

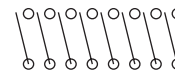

## Tape & Reel Package

ROHS PART NUMBER	NO. POS.	DIM. 'W'	QUANTITY PER REEL
<b>TDA01H0SB1R*</b>	1	16,0	2500
<b>TDA02H0_B1R</b>	2	16,0	2000
<b>TDA04H0_B1R</b>	4	16,0	2000
<b>TDA06H0_B1R</b>	6	16,0	2000
<b>TDA08H0_B1R</b>	8	24,0	2000
<b>TDA10H0_B1R</b>	10	24,0	2000

\* see next page for TDA01 tape & reel drawing

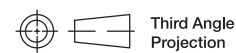

Dimensions are shown: mm  
Specifications and dimensions subject to change





# TDA Series Ultra-miniature Surface Mount Half-pitch DIP Switches



DIP I



TDA01H0SB1R

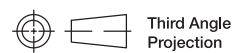
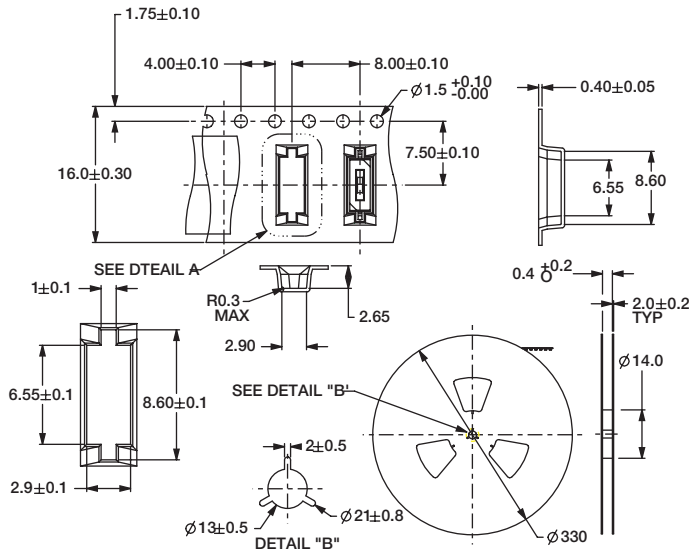

Dimensions are shown: Inch (mm)  
Specifications and dimensions subject to change

# SDA Series Low Profile DIP Switches



H  
DIP

## Features/Benefits

- Low profile design saves space
- Thru-hole and surface mount models
- Tape and reel packaging available
- RoHS compliant

## Typical Applications

- Address switch for industrial controls
- Logic switching for computers and peripherals
- Function controlling for numerous applications

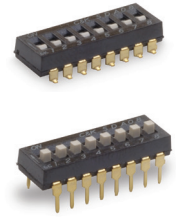

## Specifications

CONTACT RATING: 25 mA @ 24 V DC or 100 mA @ 5 V DC.

MECHANICAL AND ELECTRICAL LIFE: 1,000 cycles at rated loads.

CONTACT RESISTANCE: 50 mΩ max. initial.

INSULATION RESISTANCE: 100 MΩ between terminals.

DIELECTRIC WITHSTANDING VOLTAGE: 300 V DC min. for 1 minute.

STORAGE TEMPERATURE: -40°C to 85°C.

OPERATING TEMPERATURE: -40°C to 85°C.

OPERATING FORCE: 800 grams max.

SOLDERABILITY: Dip and look solderability testing per C&K spec. #448. Unplated edges of terminals permitted.

PACKAGING: Switches supplied in rigid dispensing tubes in full-tube quantities only, this may affect order quantity. Numbers of switches per tube varies with model. Tape and reel pack-

aging also available for surface mount options.

## Materials

HOUSING: PPS, color black (UL94V-0).

COVER: PPS, color black (UL94V-0).

ACTUATOR: PA6T (UL94-0)

CONTACTS: Gold plated Beryllium copper.

TERMINALS: Gold plate over nickel plated brass.

TAPE SEAL: Polyimide.

**Note:** Specifications and materials listed above are for switches with standard options. For information on specific and custom switches, consult Customer Service Center. For Tin Lead options consult customer service center.

## How To Order

The Build-A Switch concept allows you to mix and match options to create the switch you need. Below is a complete listing of options shown in catalog. To order, simply select desired option from each category and place in the appropriate box.

All switches supplied in "OFF" position.

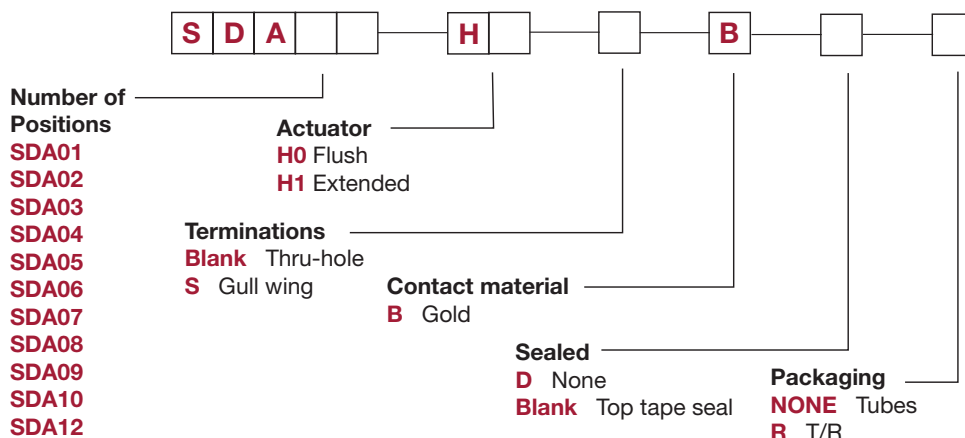

Third Angle  
Projection

Dimensions are shown: Inch (mm)  
Specifications and dimensions subject to change

# SDA Series Low Profile DIP Switches

DIP H

## Flush Actuator – No Tape, Thru-hole Terminals

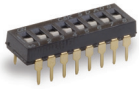

SDA08H0BD

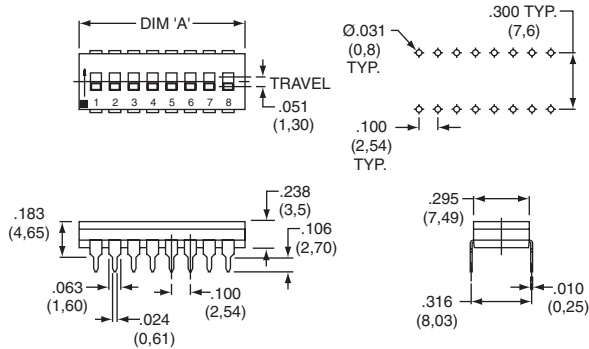

NOTE: SDA 01 options are 4,25mm thick

ROHS PART NUMBER	NO. POS.	DIM. 'A'	QUANTITY PER TUBE
<b>SDA01H0BD</b>	1	.178 (4,52)	100
<b>SDA02H0BD</b>	2	.278 (7,06)	60
<b>SDA03H0BD</b>	3	.378 (9,60)	45
<b>SDA04H0BD</b>	4	.476 (12,10)	35
<b>SDA05H0BD</b>	5	.578 (14,68)	30
<b>SDA06H0BD</b>	6	.676 (17,18)	25
<b>SDA07H0BD</b>	7	.778 (19,76)	20
<b>SDA08H0BD</b>	8	.876 (22,26)	20
<b>SDA09H0BD</b>	9	.978 (24,84)	15
<b>SDA10H0BD</b>	10	1.076 (27,34)	15
<b>SDA12H0BD</b>	12	1.279 (32,50)	14

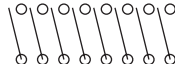
Schematic 

SPST

## Flush Actuator – With Top Tape, Thru-hole Terminals

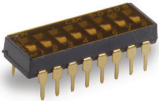

SDA08H0B

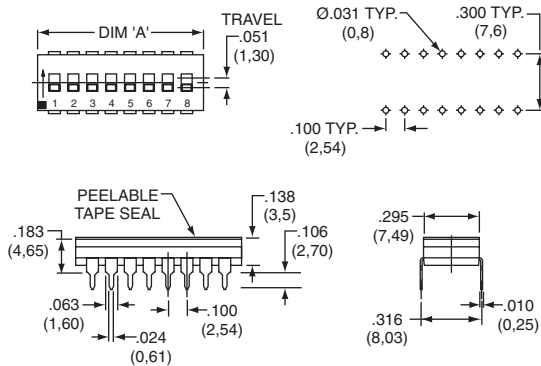

NOTE: SDA 01 options are 4,25mm thick

ROHS PART NUMBER	NO. POS.	DIM. 'A'	QUANTITY PER TUBE
<b>SDA01H0B</b>	1	.178 (4,52)	100
<b>SDA02H0B</b>	2	.278 (7,06)	60
<b>SDA03H0B</b>	3	.378 (9,60)	45
<b>SDA04H0B</b>	4	.476 (12,10)	35
<b>SDA05H0B</b>	5	.578 (14,68)	30
<b>SDA06H0B</b>	6	.676 (17,18)	25
<b>SDA07H0B</b>	7	.778 (19,76)	20
<b>SDA08H0B</b>	8	.876 (22,26)	20
<b>SDA09H0B</b>	9	.978 (24,84)	15
<b>SDA10H0B</b>	10	1.076 (27,34)	15
<b>SDA12H0B</b>	12	1.279 (32,50)	14

Schematic 

SPST

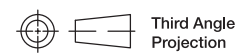

Dimensions are shown: Inch (mm)  
Specifications and dimensions subject to change

# SDA Series Low Profile DIP Switches



H  
DIP

## Flush Actuator – With Top Tape, Surface Mount Terminals

ROHS PART NUMBER	NO. POS.	DIM. 'A'	QUANTITY PER TUBE
<b>SDA01H0SB</b>	1	.178 (4,52)	100
<b>SDA02H0SB</b>	2	.278 (7,06)	60
<b>SDA03H0SB</b>	3	.378 (9,60)	45
<b>SDA04H0SB</b>	4	.476 (12,10)	35
<b>SDA05H0SB</b>	5	.578 (14,68)	30
<b>SDA06H0SB</b>	6	.676 (17,18)	25
<b>SDA07H0SB</b>	7	.778 (19,76)	20
<b>SDA08H0SB</b>	8	.876 (22,26)	20
<b>SDA09H0SB</b>	9	.978 (24,84)	15
<b>SDA10H0SB</b>	10	1.076 (27,34)	15
<b>SDA12H0SB</b>	12	1.279 (32,50)	14

Schematic

SPST

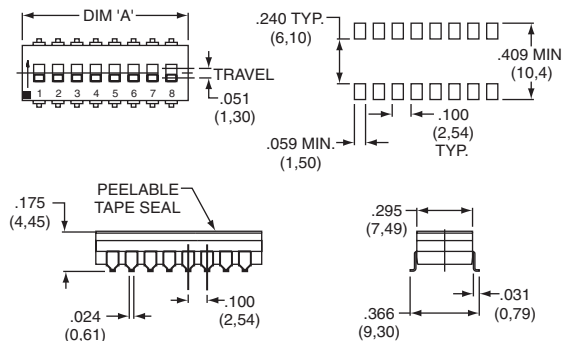

SDA08H0SB

NOTE: SDA 01 options are 4,25mm thick

## Flush Actuator – No Tape, Surface Mount Terminals

ROHS PART NUMBER	NO. POS.	DIM. 'A'	QUANTITY PER TUBE
<b>SDA01H0SBD</b>	1	.178 (4,52)	100
<b>SDA02H0SBD</b>	2	.278 (7,06)	60
<b>SDA03H0SBD</b>	3	.378 (9,60)	45
<b>SDA04H0SBD</b>	4	.476 (12,10)	35
<b>SDA05H0SBD</b>	5	.578 (14,68)	30
<b>SDA06H0SBD</b>	6	.676 (17,18)	25
<b>SDA07H0SBD</b>	7	.778 (19,76)	20
<b>SDA08H0SBD</b>	8	.876 (22,26)	20
<b>SDA09H0SBD</b>	9	.978 (24,84)	15
<b>SDA10H0SBD</b>	10	1.076 (27,34)	15
<b>SDA12H0SBD</b>	12	1.279 (32,50)	14

Schematic

SPST

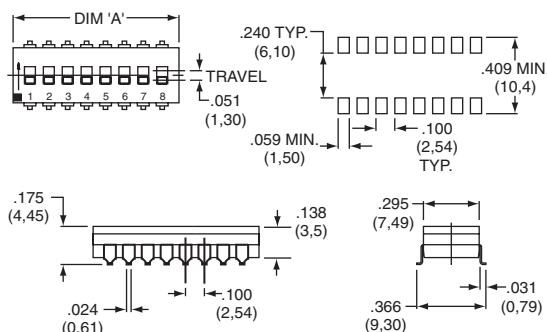

SDA08H0SBD

NOTE: SDA 01 options are 4,25mm thick

## Extended Actuator – No Top Tape, Thru-hole Terminals

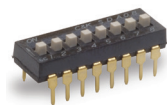

SDA08H1BD

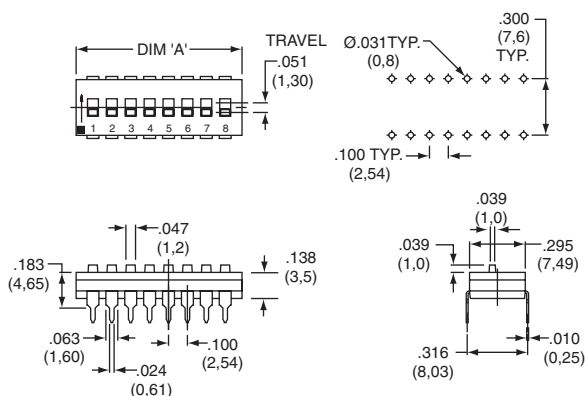

NOTE: SDA 01 options are 4,25mm thick

ROHS PART NUMBER	NO. POS.	DIM. 'A'	QUANTITY PER TUBE
<b>SDA01H1BD</b>	1	.178 (4,52)	100
<b>SDA02H1BD</b>	2	.278 (7,06)	60
<b>SDA03H1BD</b>	3	.378 (9,60)	45
<b>SDA04H1BD</b>	4	.476 (12,10)	35
<b>SDA05H1BD</b>	5	.578 (14,68)	30
<b>SDA06H1BD</b>	6	.676 (17,18)	25
<b>SDA07H1BD</b>	7	.778 (19,76)	20
<b>SDA08H1BD</b>	8	.876 (22,26)	20
<b>SDA09H1BD</b>	9	.978 (24,84)	15
<b>SDA10H1BD</b>	10	1.076 (27,34)	15
<b>SDA12H1BD</b>	12	1.279 (32,50)	14

Schematic

SPST

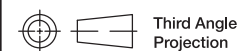

Third Angle  
Projection

Dimensions are shown: Inch (mm)  
Specifications and dimensions subject to change

# SDA Series Low Profile DIP Switches

## Extended Actuator – No Top Tape, Surface Mount Terminals



SDA08H1SBD

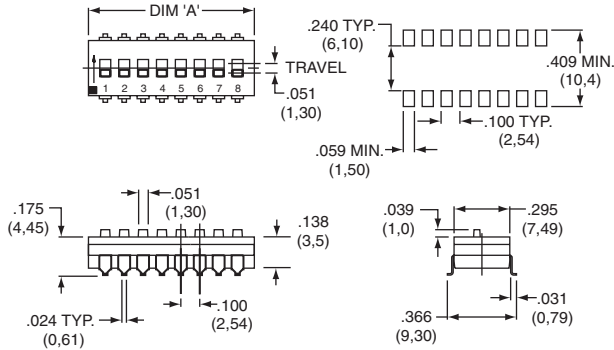

NOTE: SDA 01 options are 4,25mm thick

ROHS PART NUMBER	NO. POS.	DIM. 'A'	QUANTITY PER TUBE
<b>SDA01H1SBD</b>	1	.178 (4,52)	100
<b>SDA02H1SBD</b>	2	.278 (7,06)	60
<b>SDA03H1SBD</b>	3	.378 (9,60)	45
<b>SDA04H1SBD</b>	4	.476 (12,10)	35
<b>SDA05H1SBD</b>	5	.578 (14,68)	30
<b>SDA06H1SBD</b>	6	.676 (17,18)	25
<b>SDA07H1SBD</b>	7	.778 (19,76)	20
<b>SDA08H1SBD</b>	8	.876 (22,26)	20
<b>SDA09H1SBD</b>	9	.978 (24,84)	15
<b>SDA10H1SBD</b>	10	1.076 (27,34)	15
<b>SDA12H1SBD</b>	12	1.279 (32,50)	14

Schematic

SPST

## Tape & Reel Packaging – Surface Mount Options only

MODEL NO. 'S' OPTION	DIM. 'H' (REF.)	DIM. 'W1' (REF.)	DIM. 'W2' (REF.)	DIM. 'B' (REF.)	DIM. 'C' (REF.)	DIM. 'D' (REF.)	QUANTITY PER REEL
SDA01	H0	5.2	24.0	24.4	8.5	11.5	N/A
	H1	5.8					1500
SDA02	H0	4.8	24.0	24.4	7.9	11.5	N/A
	H1	5.8					1450
SDA03	H0	4.8	24.0	24.4	10.4	11.5	N/A
	H1	5.8					750
SDA04	H0	4.8	24.0	24.4	12.9	11.5	N/A
	H1	5.8					750
SDA05	H0	4.8	24.0	24.4	15.4	11.5	N/A
	H1	5.8					750
SDA06	H0	4.8	32.0	32.4	18.0	14.2	28.4
	H1	5.8					750
SDA07	H0	4.8	32.0	32.4	20.5	14.2	28.4
	H1						750
NOT CURRENTLY AVAILABLE IN TAPE AND REEL							
SDA08	H0	4.8	44.0	44.4	22.7	20.2	40.4
	H1	5.8					750
SDA09	H0	4.8	44.0	44.4	25.5	20.2	40.4
	H1	5.8					750
SDA10	H0	4.8	44.0	44.0	28.1	20.2	40.4
	H1	5.8					750
SDA12	H0	4.8	44.0	44.4	33.2	20.2	40.4
	H1						750
NOT CURRENTLY AVAILABLE IN TAPE AND REEL							

SDA01H1SBD OPTION SHOWN

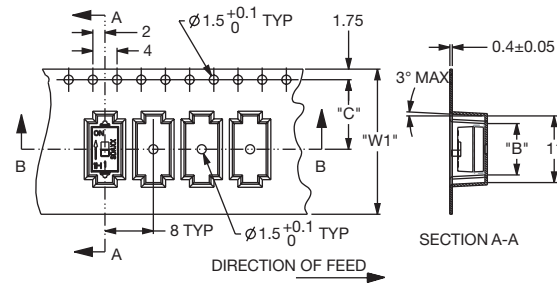

SECTION B-B

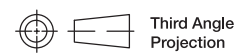
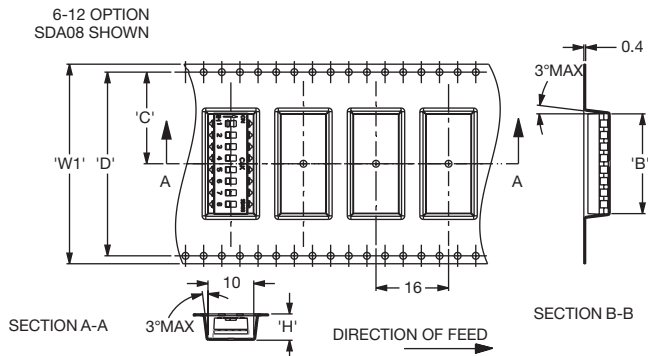
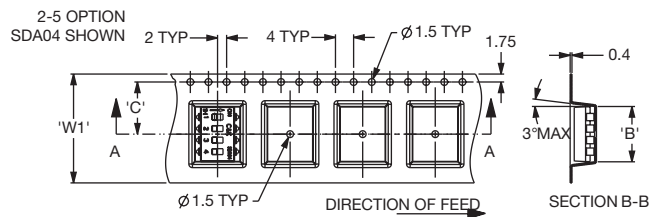
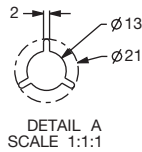
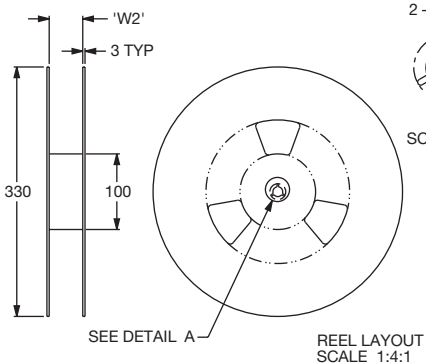

Dimensions are shown: Inch (mm)  
Specifications and dimensions subject to change

# SD Series Low Profile DIP Switches



H  
DIP

## Features/Benefits

- Low profile design saves space
- Thru-hole and surface mount models
- Tape and reel packaging available
- Sealed with top tape
- RoHS compliant

## Typical Applications

- Address switch for industrial controls
- Logic switching for computers and peripherals
- Function controlling for numerous applications

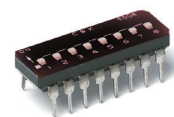

## Specifications

SWITCH FUNCTION: SPST - 2, 3, 4, 5, 6, 7, 8, 9, 10 & 12 positions

CONTACT RATING:

Carry: 100 mA @ 50 V DC max.

Switch: 0.1 mA @ 5 V DC min to 100 mA @ 25 V DC max.

MECHANICAL AND ELECTRICAL LIFE: 2,000 make-and-break cycles at full load, each circuit.

CONTACT RESISTANCE: Below 50 milliohms typ. initial @ 2-4 V DC, 100mA.

INSULATION RESISTANCE: 10<sup>9</sup> ohms min.

DIELECTRIC STRENGTH: 500 V RMS min. @ sea level between adjacent terminals.

STORAGE TEMPERATURE: -40°C to 85°C.

OPERATING TEMPERATURE: -40°C to 85°C.

OPERATING FORCE: 100-700g initial.

PACKAGING: Thru-hole switches supplied in rigid dispensing tubes in full-tube quantities only; this may effect order quantity. Surface mount switches available in tape and reel packaging by added 'R' to end of part number; 1,000 pieces per reel. Switch position 1 denotes pin number 1. All switch actuators in 'OFF' position, standard.

## Materials

CASE & COVER: (PPA), flame retardant (UL 94V-0)

ACTUATOR: Nylon, flame retardant (UL 94V-0)

CONTACTS: BeCu with gold plate.

TERMINALS: Bright tin-plated brass.

TERMINAL SEAL: All terminals insert molded.

TAPE SEAL: Polyimide.

**Note:** Specifications and materials listed above are for switches with standard options. For information on specific and custom switches, consult Customer Service Center.

## How To Order

The Build-A Switch concept allows you to mix and match options to create the switch you need. Below is a complete listing of options shown in catalog. To order, simply select desired option from each category and place in the appropriate box.

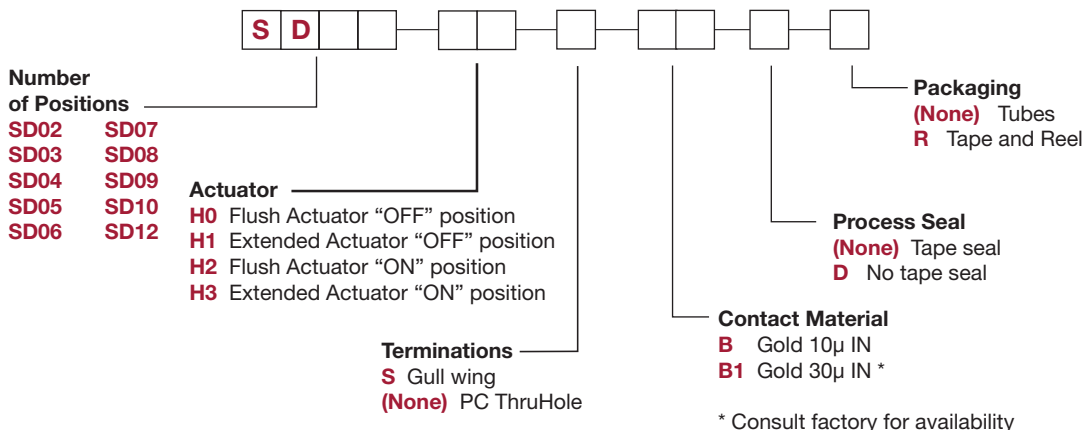

Dimensions are shown: Inch (mm)  
Specifications and dimensions subject to change



9 January 2018

# SD Series Low Profile DIP Switches

DIP H

## Sealed Flush Actuator – With Top Tape, Thru-hole Terminals

Process sealed - withstands soldering and cleaning processes

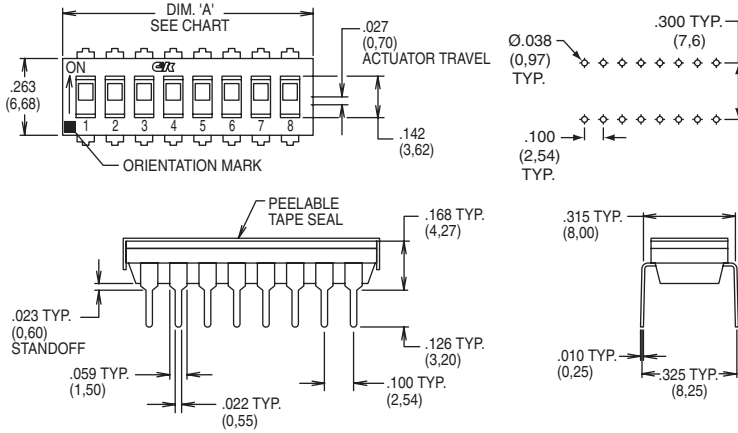

ROHS PART NUMBER	NO. POS.	DIM. 'A'	QUANTITY PER TUBE
<b>SD02H0B</b>	2	.258 (6,55)	85
<b>SD03H0B</b>	3	.358 (9,09)	60
<b>SD04H0B</b>	4	.458 (11,63)	45
<b>SD05H0B</b>	5	.558 (14,17)	40
<b>SD06H0B</b>	6	.658 (16,71)	30
<b>SD07H0B</b>	7	.758 (19,25)	25
<b>SD08H0B</b>	8	.858 (21,79)	25
<b>SD09H0B</b>	9	.958 (24,33)	20
<b>SD10H0B</b>	10	1.058 (26,87)	20
<b>SD12H0B</b>	12	1.258 (31,95)	15

Schematic



SPST

Table applicable to "H0" and "H2" actuator options.

## Sealed Flush Actuator – With Top Tape, Surface Mount Terminals

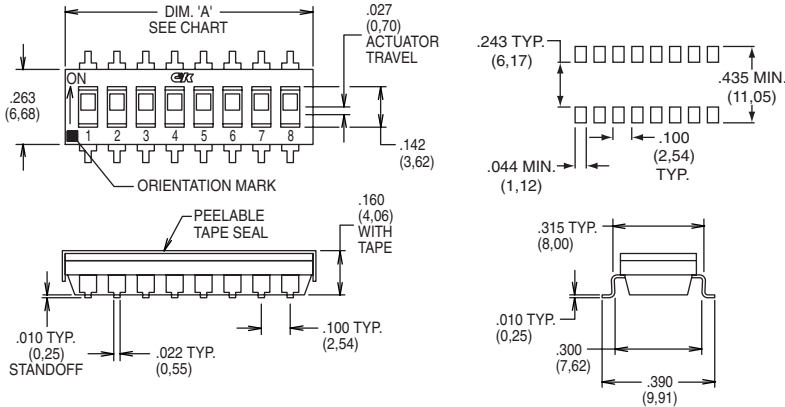

RoHS PART NUMBER	NO. POS.	DIM. 'A'	QUANTITY PER TUBE
<b>SD02H0SB</b>	2	.258 (6,55)	85
<b>SD03H0SB</b>	3	.358 (9,09)	60
<b>SD04H0SB</b>	4	.458 (11,63)	45
<b>SD05H0SB</b>	5	.558 (14,17)	40
<b>SD06H0SB</b>	6	.658 (16,71)	30
<b>SD07H0SB</b>	7	.758 (19,25)	25
<b>SD08H0SB</b>	8	.858 (21,79)	25
<b>SD09H0SB</b>	9	.958 (24,33)	20
<b>SD10H0SB</b>	10	1.058 (26,87)	20
<b>SD12H0SB</b>	12	1.258 (31,95)	15

Schematic



SPST

Table applicable to "H0" and "H2" actuator options.

## Sealed Extended Actuator – With Top Tape, Thru-hole Terminals

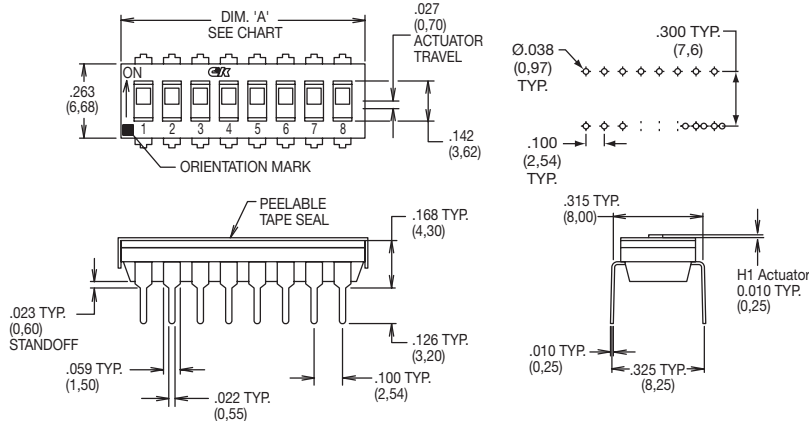

RoHS PART NUMBER	NO. POS.	DIM. 'A'	QUANTITY PER TUBE
<b>SD02H1B</b>	2	.258 (6,55)	85
<b>SD03H1B</b>	3	.358 (9,09)	60
<b>SD04H1B</b>	4	.458 (11,63)	45
<b>SD05H1B</b>	5	.558 (14,17)	40
<b>SD06H1B</b>	6	.658 (16,71)	30
<b>SD07H1B</b>	7	.758 (19,25)	25
<b>SD08H1B</b>	8	.858 (21,79)	25
<b>SD09H1B</b>	9	.958 (24,33)	20
<b>SD10H1B</b>	10	1.058 (26,87)	20
<b>SD12H1B</b>	12	1.258 (31,95)	15

Schematic



SPST

Table applicable to "H1" and "H3" actuator options.

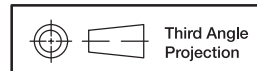

Third Angle Projection

# SD Series Low Profile DIP Switches

H DIP

## Sealed Extended Actuator – With Top Tape, Surface Mount Terminals

RoHS PART NUMBER	NO. POS.	DIM. 'A'	QUANTITY PER TUBE
<b>SD02H1SB</b>	2	.258 (6,55)	85
<b>SD03H1SB</b>	3	.358 (9,09)	60
<b>SD04H1SB</b>	4	.458 (11,63)	45
<b>SD05H1SB</b>	5	.558 (14,17)	40
<b>SD06H1SB</b>	6	.658 (16,71)	30
<b>SD07H1SB</b>	7	.758 (19,25)	25
<b>SD08H1SB</b>	8	.858 (21,79)	25
<b>SD09H1SB</b>	9	.958 (24,33)	20
<b>SD10H1SB</b>	10	1.058 (26,87)	20
<b>SD12H1SB</b>	12	1.258 (31,95)	15

Schematic

SPST

Table applicable to "H1" and "H3" actuator options.

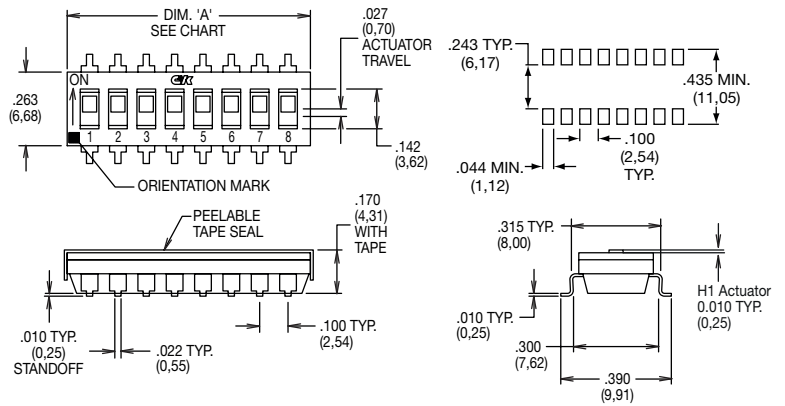

## TAPE & REEL PACKAGING – SURFACE MOUNT OPTIONS ONLY

RoHS PART NUMBER	NO. POS.	DIM. 'A'	QUANTITY PER REEL
<b>SD02H0SBR</b>	2	.258 (6,55)	1000
<b>SD03H0SBR</b>	3	.358 (9,09)	1000
<b>SD04H0SBR</b>	4	.458 (11,63)	1000
<b>SD05H0SBR</b>	5	.558 (14,17)	1000
<b>SD06H0SBR</b>	6	.658 (16,71)	1000
<b>SD07H0SBR</b>	7	.758 (19,25)	1000
<b>SD08H0SBR</b>	8	.858 (21,79)	1000
<b>SD09H0SBR</b>	9	.958 (24,33)	1000
<b>SD10H0SBR</b>	10	1.058 (26,87)	1000
<b>SD12H0SBR</b>	12	1.258 (31,95)	1000

Schematic

SPST

Table applicable to "H0" and "H2" actuator options.

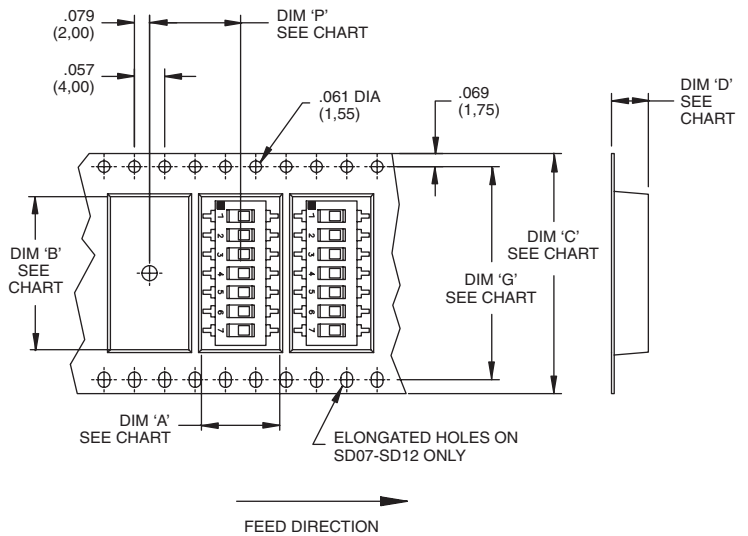

SWITCH NO.	DIM 'A' POCKET LENGTH @ BOTTOM	DIM 'B' POCKET LENGTH @ BOTTOM	DIM 'C' TAPE WIDTH	DIM 'D' POCKET DEPTH	DIM 'G' SPROCKET HOLE SPACING	DIM 'P' PITCH BETWEEN POCKETS
SD02	.413(10,5)	.315(8,0)	.630(16,0)	.177(4,5)	N/A	.472(12,0)
SD03	.406(10,3)	.406(10,3)	.630(16,0)	.177(4,5)	N/A	.472(12,0)
SD04	.429(10,9)	.476(12,1)	.954(24,0)	.177(4,5)	N/A	.472(12,0)
SD05	.406(10,3)	.602(15,3)	.954(24,0)	.177(4,5)	N/A	.472(12,0)
SD06	.406(10,3)	.701(17,8)	.954(24,0)	.177(4,5)	N/A	.472(12,0)
SD07	.406(10,3)	.803(20,4)	1.260(32,0)	.177(4,5)	1.118(28,4)	.472(12,0)
SD08	.406(10,3)	.854(21,7)	1.732(44,0)	.177(4,5)	1.591(40,4)	.472(12,0)
SD09	.406(10,3)	1.028(26,1)	1.732(44,0)	.177(4,5)	1.591(40,4)	.472(12,0)
SD10	.406(10,3)	1.055(26,8)	1.732(44,0)	.177(4,5)	1.591(40,4)	.472(12,0)
SD12	.406(10,3)	1.303(33,1)	1.732(44,0)	.177(4,5)	1.591(40,4)	.472(12,0)

### Reel Information

Outside diameter 13.00 (333,0)  
Pilot hole .512 (13,0)

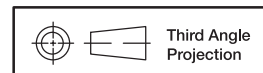

Dimensions are shown: Inch (mm)  
Specifications and dimensions subject to change



9 January 2018



# BD Series Standard Profile DIP Switches



DIP

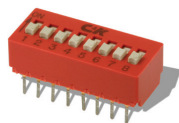

## Features/Benefits

- Traditional full profile DIP switch
- Extended actuator for easy actuation
- Open bottom construction allows for solder washing without the need for tape seal
- RoHS compliant

## Typical Applications

- Address switch for industrial controls
- Logic switching for computers and peripherals
- Function controlling for numerous applications

## Specifications

SWITCH FUNCTION: SPST - 1 thru 12 position available (except 11 position).

CONTACT RATING:

Carry: 100 mA max. @ 50 V DC.

Switch: 100 mA max. @ 5 V DC or 25 mA max. @ 25 V DC.

MECHANICAL AND ELECTRICAL LIFE: 10,000 make-and-break cycles at full load, each circuit.

CONTACT RESISTANCE: Below 50 milliohms typ. initial @ 2-4 V DC 100mA.

INSULATION RESISTANCE: 10<sup>9</sup> ohms min.

DIELECTRIC STRENGTH: 500 V RMS min. @ sea level between adjacent terminals.

CAPACITANCE: 5pF max. between adjacent terminals.

STORAGE & OPERATING TEMPERATURE: -40°C to 85°C.

SHOCK: Withstands 20g 11 ms sawtooth waveform with no contact opening greater than 10 microseconds.

VIBRATION: No contact opening greater than 10 microseconds and no contact closure when exposed to vibration .06 in DA or 5g, whichever is less, from 10 to 55 Hz, and 10g from 55 to 500 Hz.

SOLDERABILITY: Per MIL-STD-202F method 208D, or EIA RS-186E method 9 (1 hour steam aging).

PACKAGING: Switches supplied in rigid dispensing tubes in full-tube quantities only: this may effect order quantity. Number of switches per tube varies with model. Switch position 1 denotes pin number 1. All switch actuators in 'OFF' position, standard.

## Materials

CASE & COVER: Glass filled polyester (PBT), flame retardant (UL 94V-0).

ACTUATOR: Glass filled nylon 6/6, flame retardant, heat stabilized (UL 94V-0)

CONTACTS: Gold over nickel over phosphor bronze.

TERMINALS: Matte-tin over nickel over phosphor bronze.

**Note:** Specifications and materials listed above are for switches with standard options. For information on specific and custom switches, consult Customer Service Center.

## How To Order

Our easy build-a-switch concept allows you to mix and match options to create the switch you need. To order, select desired option from each category and place it in the appropriate box.

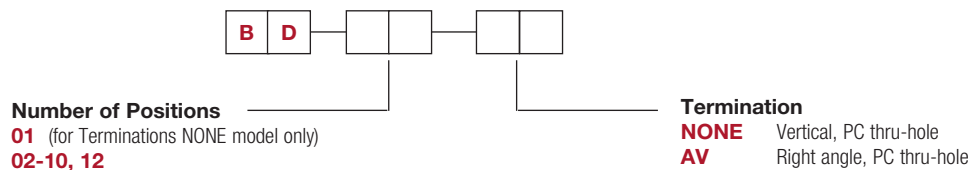

Dimensions are shown: Inch (mm)  
 Specifications and dimensions subject to change



15 Mar 22

# BD Series Standard Profile DIP Switches

DIP

H DIP

## Vertical Full Profile DIP

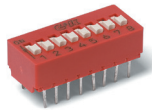

BD08

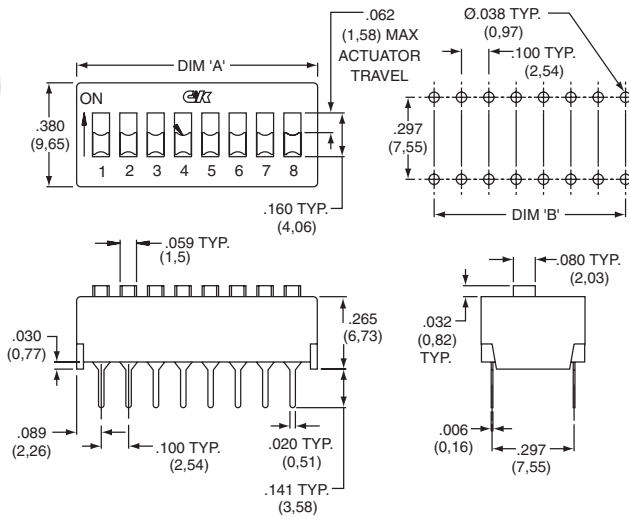

PART NUMBER	NO.POS.	DIM. 'A'	DIM. 'B'	QUANTITY PER TUBE
<b>BD01</b>	1	.180 (4,57)	NA	115
<b>BD02</b>	2	.280 (7,11)	.100 (2,54)	74
<b>BD03</b>	3	.380 (9,65)	.200 (5,08)	54
<b>BD04</b>	4	.480 (12,19)	.300 (7,62)	43
<b>BD05</b>	5	.580 (14,73)	.400 (10,16)	35
<b>BD06</b>	6	.680 (17,27)	.500 (12,75)	30
<b>BD07</b>	7	.780 (19,81)	.600 (15,24)	26
<b>BD08</b>	8	.880 (22,35)	.700 (17,78)	23
<b>BD09</b>	9	.980 (24,89)	.800 (20,32)	21
<b>BD10</b>	10	1.080 (27,43)	.900 (22,86)	19
<b>BD12</b>	12	1.280 (32,51)	1.100 (27,94)	16

Schematic

SPST

## Open Base and AV Right Angle Terminal Style

PART NUMBER	NO.POS.	DIM. 'A'	QUANTITY PER TUBE
<b>BD02AV</b>	2	.280 (7,11)	72
<b>BD03AV</b>	3	.380 (9,65)	52
<b>BD04AV</b>	4	.480 (12,19)	42
<b>BD05AV</b>	5	.580 (14,73)	35
<b>BD06AV</b>	6	.680 (17,27)	29
<b>BD07AV</b>	7	.780 (19,81)	26
<b>BD08AV</b>	8	.880 (22,35)	23
<b>BD09AV</b>	9	.980 (24,89)	20
<b>BD10AV</b>	10	1.080 (27,43)	18
<b>BD12AV</b>	12	1.280 (32,51)	15

Schematic

SPST

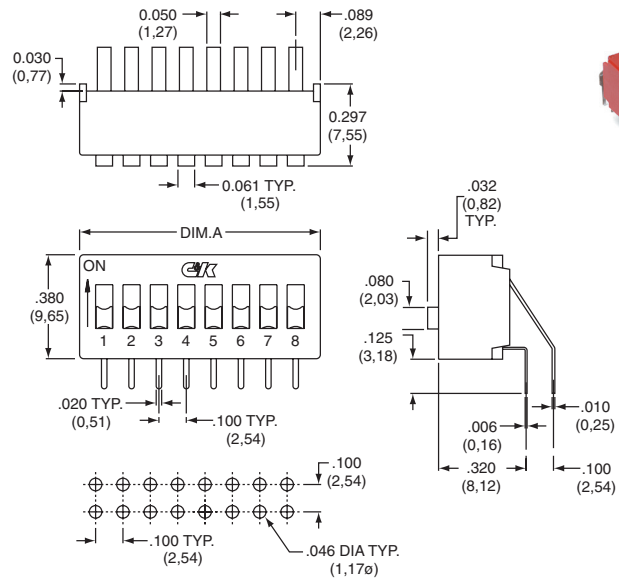

BD08AV

## Installation, Soldering and Cleaning

All BD Series Standard Profile DIP Switches can be hand soldered or machine soldered without the use of boot, caps, tapes or special attention. Open base washable models have unique design, allowing solvent cleaners and water/detergent solutions to flush and clean the electrical contacts of the contaminants and fluxes. For best results, follow these directions:

- 1) Wave soldering recommended at 500° F (260°C) solder temperature.
- 2) Hand solder using 30 watt small tip iron controlled at 500° F (260°C), 10 seconds max./terminal.
- 3) Open base washable models: Clean flux using forced rinse, high agitation or triple bath cleaning method. DO NOT mask or cover switch in any way during cleaning. Switch is designed for easy solvent flush out.
- 4) All switch actuators must be in 'OFF' position during soldering and cleaning processes.

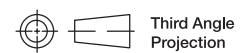

15 Mar 22

Dimensions are shown: Inch (mm)  
Specifications and dimensions subject to change

# BPA Series Side Actuated DIP Switches

INDUSTRIAL  
ELECTRONICS

DI

DIP

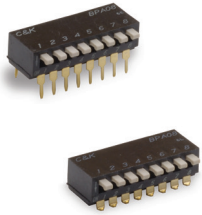

## Features/Benefits

- Side actuated contacts
- Available in thru-hole or SMT models
- High pressure contact system does not require tape seal for washing
- RoHS compliant & compatible

## Typical Applications

- Address switch for industrial controls
- Logic switching for computers and peripherals
- Function controlling for numerous applications

## Specifications

SWITCH FUNCTION: 1 thru 10 and 12 position available.  
 CONTACT RATING: 100 mA max. @ 5 V DC or 25 mA max. @ 24 V DC.  
 MECHANICAL AND ELECTRICAL LIFE: 1,000 cycles min. @ 5 V DC 10mA.  
 CONTACT RESISTANCE: 50 milliohms initial max.  
 INSULATION RESISTANCE: 100 V DC 100 megohms min.  
 DIELECTRIC WITHSTAND VOLTAGE: 300 V AC for 1 minute.  
 STORAGE TEMPERATURE: -40°C to 85°C.  
 OPERATING TEMPERATURE: -20°C to 85°C.  
 OPERATING FORCE: 800 grams max.  
 SOLDERABILITY: Flow solderable and washable (soldering: 260°C for 10 sec. max.)

PACKAGING: Switches supplied in rigid dispensing tubes in full-tube quantities only, this may affect order quantity. Numbers of switches per tube varies with model. Tape and reel packaging available for SMT options.

## Materials

HOUSING: PPS, color black (UL94V-0).  
 COVER: PPS, color black (UL94V-0).  
 ACTUATOR: PA-6T (UL94V-0).  
 CONTACTS: Beryllium Copper with Gold over Nickel plate.  
 TERMINALS: Brass, Gold over Nickel plate.

**Note:** Specifications and materials listed above are for switches with standard options. For information on specific and custom switches, consult Customer Service Center.

## How To Order

The Build-A Switch concept allows you to mix and match options to create the switch you need. Below is a complete listing of options shown in catalog. To order, simply select desired option from each category and place in the appropriate box.

All switches supplied in "OFF" position.

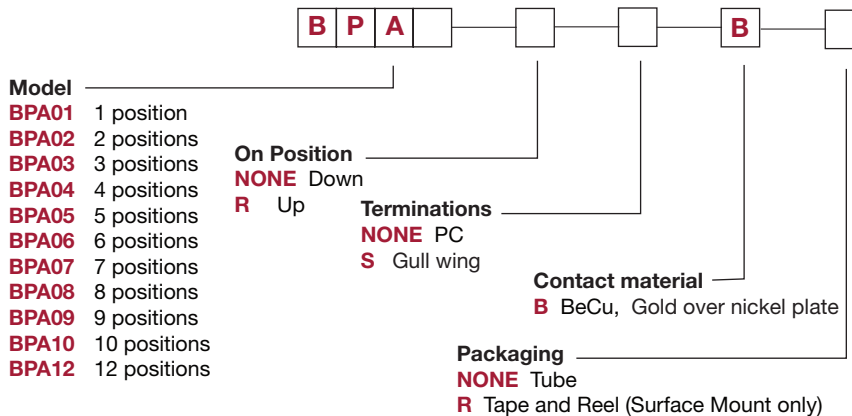

Dimensions are shown: Inch (mm)

Specifications and dimensions subject to change



13 feb 19

# BPA Series Side Actuated DIP Switches

## Side Actuator – Thru-hole Terminals

ROHS PART NUMBER	NO. POS.	DIM. 'A'	DIM. 'B'	QUANTITY PER TUBE
<b>BPA01B</b>	1	.176 (4,48)	N/A	100
<b>BPA02B</b>	2	.276 (7,0)	.100 (2,54)	60
<b>BPA03B</b>	3	.376 (9,6)	.200 (5,08)	45
<b>BPA04B</b>	4	.476 (12,1)	.300 (7,62)	35
<b>BPA05B</b>	5	.575 (14,6)	.400 (10,16)	30
<b>BPA06B</b>	6	.677 (17,2)	.500 (12,70)	25
<b>BPA07B</b>	7	.776 (19,7)	.600 (15,24)	20
<b>BPA08B</b>	8	.878 (22,3)	.700 (17,78)	20
<b>BPA09B</b>	9	.976 (24,8)	.800 (20,32)	15
<b>BPA10B</b>	10	1.075 (27,3)	.900 (22,86)	15
<b>BPA12B</b>	12	1.280 (32,5)	1.100 (27,94)	14

Schematic

SPST

**NOTE:** Reverse throw available, contact C&K for P/N and quote.



BPA08B

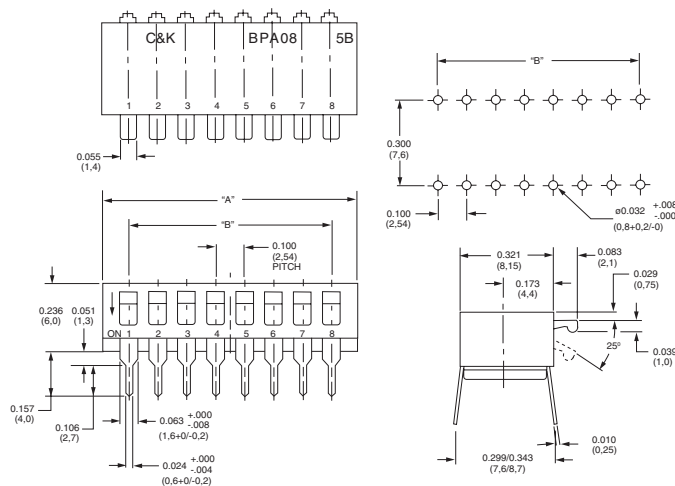

## Side Actuator – Surface Mount Terminals

ROHS PART NUMBER	NO. POS.	DIM. 'A'	DIM. 'B'	QUANTITY PER TUBE
<b>BPA01SB</b>	1	.176 (4,48)	N/A	100
<b>BPA02SB</b>	2	.276 (7,0)	.100 (2,54)	60
<b>BPA03SB</b>	3	.376 (9,6)	.200 (5,08)	45
<b>BPA04SB</b>	4	.476 (12,1)	.300 (7,62)	35
<b>BPA05SB</b>	5	.575 (14,6)	.400 (10,16)	30
<b>BPA06SB</b>	6	.677 (17,2)	.500 (12,70)	25
<b>BPA07SB</b>	7	.776 (19,7)	.600 (15,24)	20
<b>BPA08SB</b>	8	.878 (22,3)	.700 (17,78)	20
<b>BPA09SB</b>	9	.976 (24,8)	.800 (20,32)	15
<b>BPA10SB</b>	10	1.075 (27,3)	.900 (22,86)	15
<b>BPA12SB</b>	12	1.280 (32,5)	1.100 (27,94)	14

Schematic

SPST

**NOTE:** Tape and reel packaging available by adding "R" to end of project number.



BPA08SB

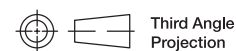
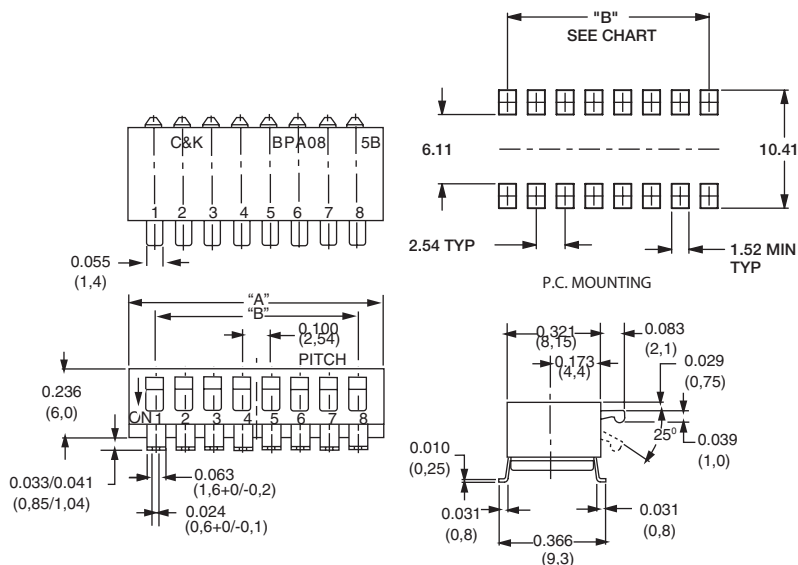

Dimensions are shown: Inch (mm)  
Specifications and dimensions subject to change

# BPA Series Side Actuated DIP Switches

DIP H

## Tape & Reel Packaging – Surface Mount Options Only

QTY/ REEL	POLES	DIM. 'A'	DIM. 'B'	DIM. 'C'	DIM. 'D'	DIM. 'E'
500	1	.453 (11,5)	—	.945 (24,0)	.530 (13,45)	.960 (24,4)
500	2	.453 (11,5)	—	.945 (24,0)	.311 (7,9)	.960 (24,4)
500	3	.453 (11,5)	—	.945 (24,0)	.409 (10,4)	.960 (24,4)
500	4	.453 (11,5)	—	.945 (24,0)	.508 (12,9)	.960 (24,4)
500	5	.453 (11,5)	—	.945 (24,0)	.606 (15,4)	.960 (24,4)
500	6	.559 (14,2)	1.118 (28,4)	1.260 (32,0)	.709 (18,0)	1.275 (32,4)
500	7	.559 (14,2)	1.118 (28,4)	1.260 (32,0)	.807 (20,5)	1.275 (32,4)
500	8	.795 (20,2)	1.590 (40,4)	1.732 (44,0)	.894 (22,7)	1.748 (44,4)
500	9	.795 (20,2)	1.590 (40,4)	1.732 (44,0)	1.004 (25,5)	1.748 (44,4)
500	10	.795 (20,2)	1.590 (40,4)	1.732 (44,0)	1.106 (28,1)	1.748 (44,4)
500	12	.795 (20,2)	1.590 (40,4)	1.732 (44,0)	1.311 (33,3)	1.748 (44,4)

Note: For tape and reel packaging, add 'R' to end of part number.

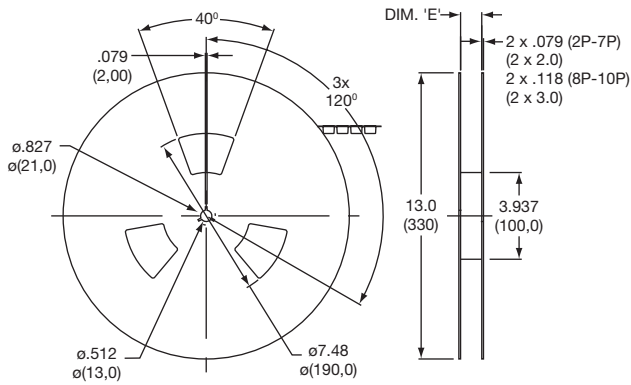

### 2, 3, 4 & 5 Positions

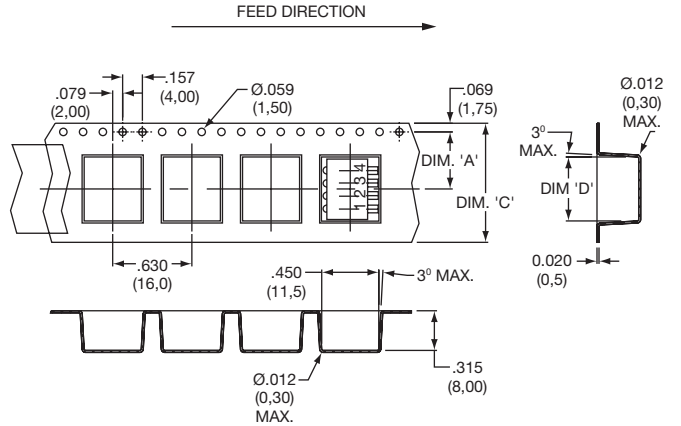

### 6, 7, 8, 9, 10 & 12 Positions

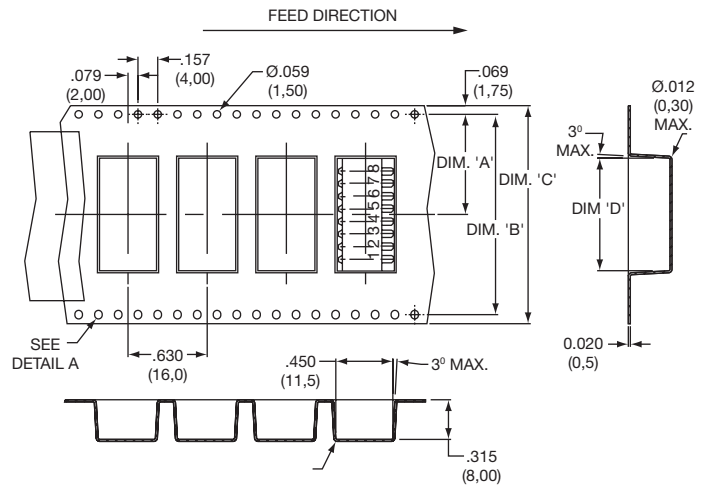

## Tube Packaging

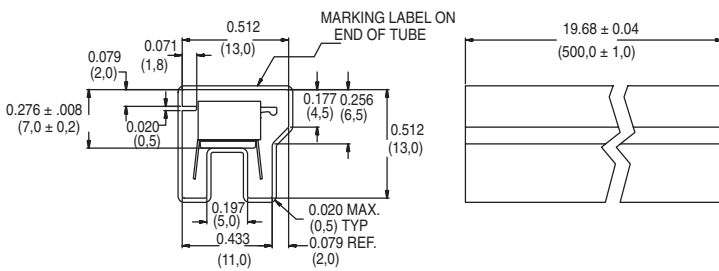

### 1 Position

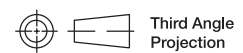
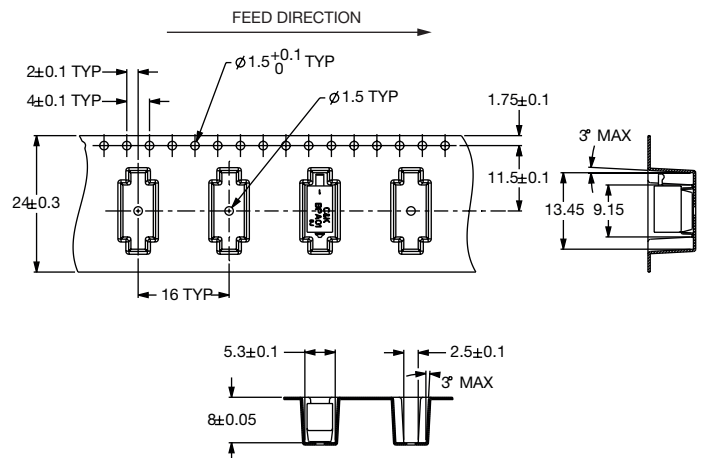

Dimensions are shown: Inch (mm)  
Specifications and dimensions subject to change



H  
DIP

## Features/Benefits

- **Bifurcated contact for increased electrical reliability**
- **Process sealed for surface mount soldering and washable processing**
- **RoHS compliant**

## Typical Applications

- **Hand-held electronic devices**
- **Portable computer and electronic devices**
- **Instrumentation and controls**
- **Inverters**



## Specifications

CONTACT RATING: 25 mA @ 24 V DC (switching) or  
100 mA @ 50 V DC (steady state).

MECHANICAL AND ELECTRICAL LIFE: 200 cycles at rated loads.

CONTACT RESISTANCE: 100 mΩ max. initial. @ 2 V DC /10 mA

INSULATION RESISTANCE: 100 MΩ @ 100 V DC min.

DIELECTRIC STRENGTH: 300 V AC /minute

STORAGE TEMPERATURE: -40°C to 85°C.

OPERATING TEMPERATURE: -40°C to 85°C.

OPERATING FORCE: 4.9 N max.

SOLDERABILITY: Per MIL-STD-202F method 208D, or  
EIA RS-186E method 9 (1 hour steam aging).

PACKAGING: 1,000 pieces tape & reel

## Materials

CASE AND COVER: PPS, color black (UL94V-0).

ACTUATOR: LCP (UL94-0)

CONTACTS: Copper alloy with gold plate over nickel plate

TERMINALS (INSERT MOLDED):

Copper alloy gold flash over nickel plate

TAPE SEAL: Polyamide

**Note:** Specifications and materials listed above are for switches with standard options. For information on specific and custom switches, consult Customer Service Center. For Tin Lead options consult customer service center.

## How To Order

The Build-A Switch concept allows you to mix and match options to create the switch you need. Below is a complete listing of options shown in catalog. To order, simply select desired option from each category and place in the appropriate box.

All switches supplied in "OFF" position..

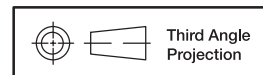
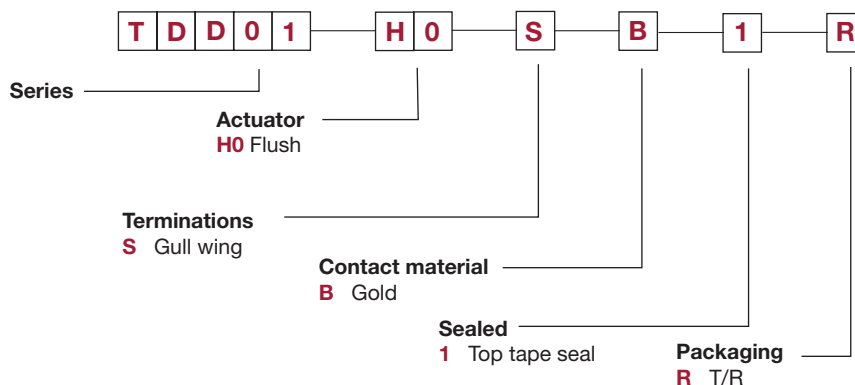

Dimensions are shown: Inch (mm)  
Specifications and dimensions subject to change

# TDD Series Jumper Switch



DIP I

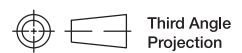
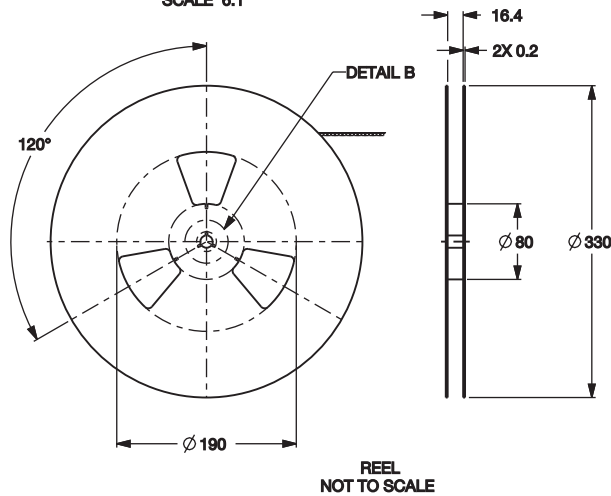
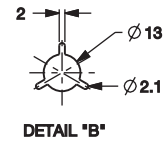
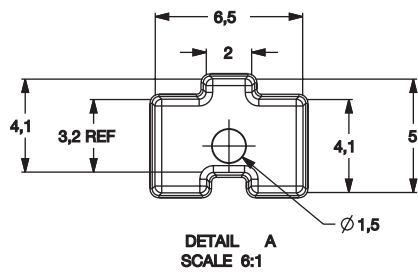
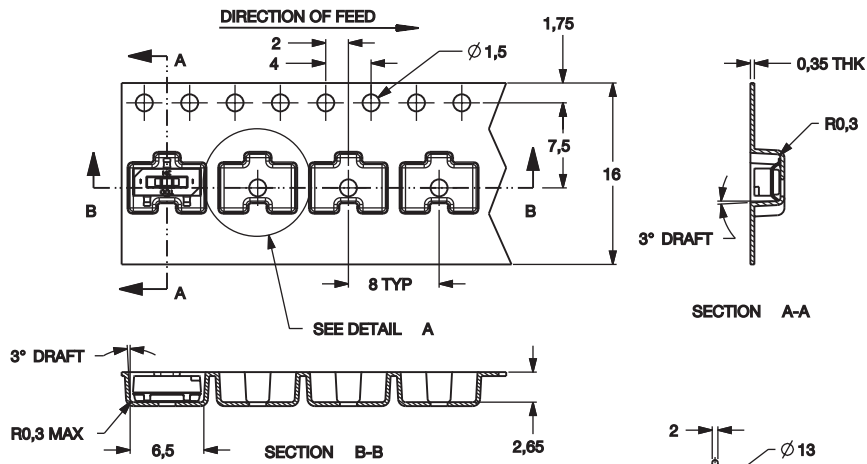
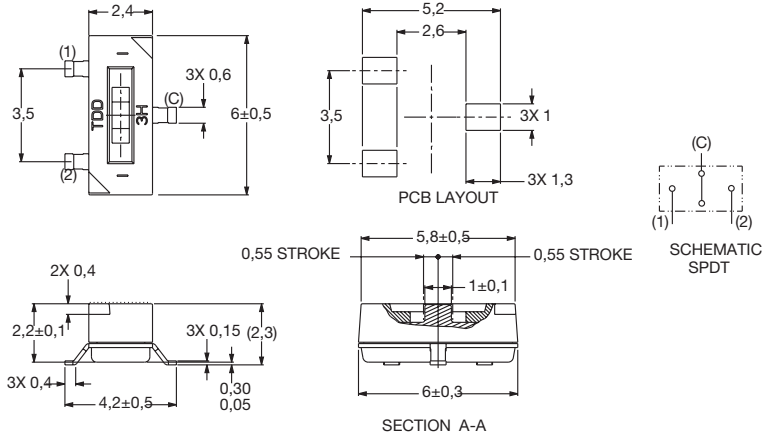

# SPA Series Single In-line Package Switches



H  
DIP

## Features/Benefits

- **Thin Single In-line Packaging saves PCB space**
- **Retention feature holds part to PCB prior to soldering**
- **Available in vertical or right angle models**
- **High pressure contact system does not require tape sealing**
- **RoHS compliant**

## Typical Applications

- **Address switch for industrial controls**
- **Logic switching for computers and peripherals**
- **Function controlling for numerous applications**

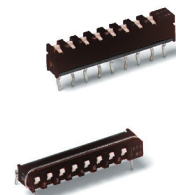

## Specifications

### CONTACT RATING:

Carry: 10 mA @ 5VDC

Switching: 0.1 mA @ 0.1m VDC min.

MECHANICAL AND ELECTRICAL LIFE: 1,000 cycles min.

CONTACT RESISTANCE: 50 mΩ max. @ 20 V DC 10mA.

INSULATION RESISTANCE: 100 MΩ min. @ 100 V DC.

DIELECTRIC STRENGTH: 1 minute @ 300 V AC.

CAPACITANCE: 5pF max. between adjacent terminals.

OPERATING TEMPERATURE: -40°C to 85°C.

STORAGE TEMPERATURE: -40°C to 85°C.

OPERATING FORCE: 5.9N max.

SOLDERABILITY: Dip & look solderability testing per C&K spec.

#448. Unplated edges of terminals permitted.

PACKAGING: Switches supplied in rigid dispensing tubes in full-tube quantities only, this may affect order quantity. Numbers of switches per tube varies with model.

## Materials

BASE: PPS (UL94V-0).

COVER: PBT (UL94V-0).

ACTUATOR: 4/6 Nylon (UL 94V-0).

MOVABLE CONTACT: Beryllium copper alloy, gold over nickel plate.

FIXED CONTACT: Copper alloy, gold over nickel plate.

CLIP: Phosphor bronze wire. Phosphor bronze, Tin over nickel plate.

**Note:** Specifications and materials listed above are for switches with standard options. For information on specific and custom switches, consult Customer Service Center.

## How To Order

The Build-A Switch concept allows you to mix and match options to create the switch you need. Below is a complete listing of options shown in catalog. To order, simply select desired option from each category and place in the appropriate box.

All switches supplied in "OFF" position.

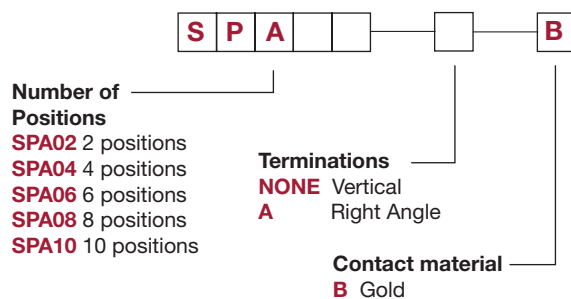

Dimensions are shown: Inch (mm)  
Specifications and dimensions subject to change



# SPA Series Single In-line Package Switches

## Vertical

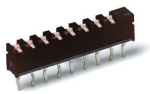

SPA08B

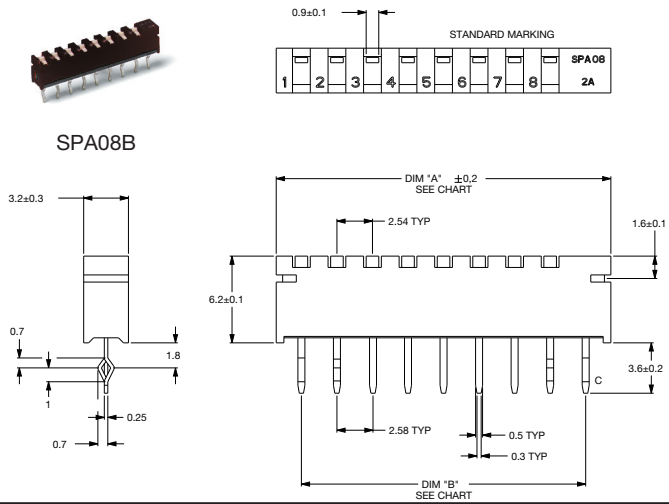

ROHS PART NUMBER	NO. POS.	DIM. 'A'	DIM. 'B'	QUANTITY PER TUBE
<b>SPA02B</b>	2	.342 (8,68)	.200 (5,08)	50
<b>SPA04B</b>	4	.542 (13,76)	.400 (10,16)	30
<b>SPA06B</b>	6	.742 (18,84)	.600 (15,24)	25
<b>SPA08B</b>	8	.942 (23,92)	.800 (20,32)	20
<b>SPA10B</b>	10	1.142 (29,00)	1.000 (25,40)	15

Schematic

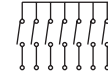

SPST

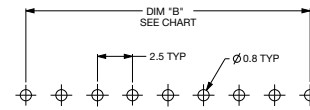

PCB MOUNTING FOOTPRINT



SPA08AB

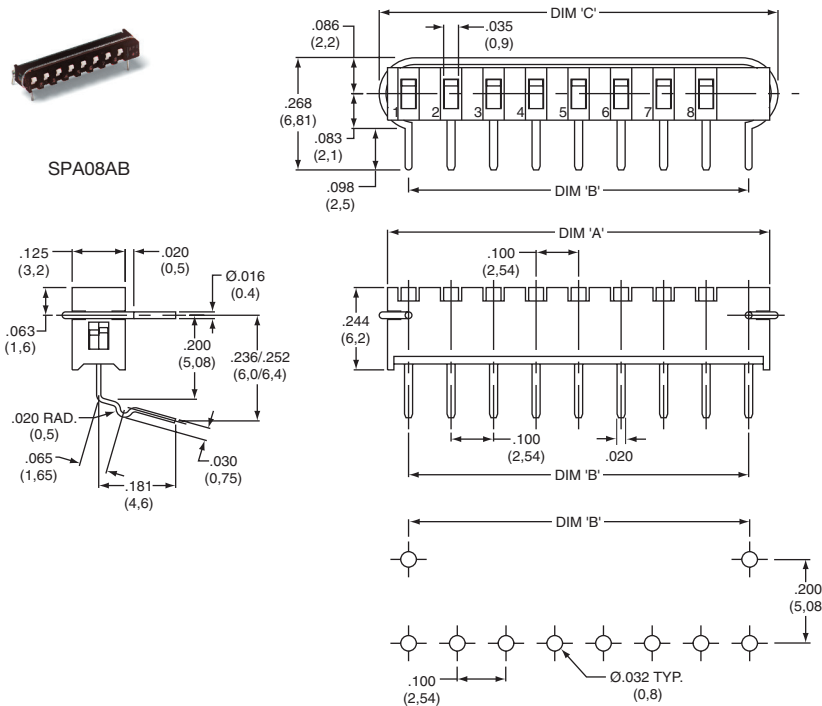

ROHS PART #	NO. POS.	DIM. 'A'	DIM. 'B'	DIM. 'C'	QTY PER TUBE
<b>SPA02AB</b>	2	.342 (8,68)	.200 (5,08)	.339 (8,6)	50
<b>SPA04AB</b>	4	.542 (13,76)	.400 (10,16)	.540 (13,7)	30
<b>SPA06AB</b>	6	.742 (18,84)	.600 (15,24)	.736 (18,7)	25
<b>SPA08AB</b>	8	.942 (23,92)	.800 (20,32)	.937 (23,8)	20
<b>SPA10AB</b>	10	1.142 (29,00)	1.000 (25,40)	1.138 (28,9)	15

Schematic

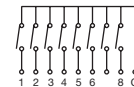

SPST

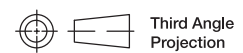

Third Angle Projection

# RTE Series Low Profile Rotary DIP Switches

ROHS COMPLIANT

H

DIP

## Features/Benefits

- Thru-hole & surface mount models
- Miniature size with robust metal cover in black or silver nickel finish
- 4, 10 & 16 positions
- Large choice of codings
- Vertical, right angle or reverse versions
- IP54
- RoHS compliant

## Typical Applications

- Timers, automation components
- Computer and peripherals
- Alarms, access control, smoke detectors, lighting, home protection
- Instrumentation

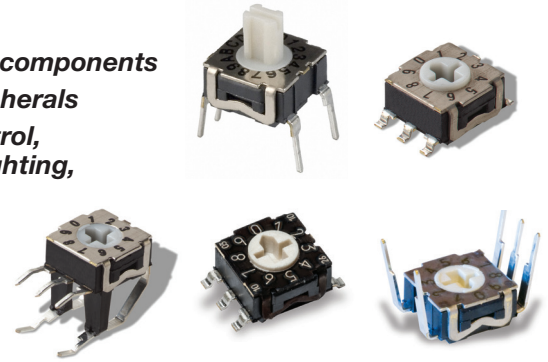

## Specifications

### CONTACT RATING:

Gold: 100 mA max. 10 $\mu$  A min. 30 V DC max. 20 mVDC min.

MECHANICAL LIFE: 20,000 indexations

CONTACT RESISTANCE: 100 m $\Omega$  max. initial;  
150 m $\Omega$  after life

INSULATION RESISTANCE: 10<sup>10</sup>  $\Omega$  min. initial

DIELECTRIC STRENGTH: 300 Vrms 1 mn

OPERATING TEMPERATURE: -25°C to 85°C.

STORAGE TEMPERATURE: -55°C to 85°C.

PACKAGING:

Quantities

Terminations	Actuator	Tube	Box (in bulk)	Carrier tape	Standard Package
G	Flush, screwdriver slot			1250	1250 (1 reel)
	Shaft for button			750	750 (1 reel)
N	All versions	65			1950 (30 tubes)
V	All versions		150		1500 (10 boxes)
R	Flush, screwdriver slot	65			1950 (30 tubes)
	Shaft for button		150		1500 (10 boxes)

## Materials

COVER: Brass, nickel plated (black or silver)

BASE: PPS

ACTUATOR: LCP

MOVABLE CONTACTS: Copper alloy, gold plated.

STATIONARY CONTACTS: Brass, gold plated.

TERMINALS: See page I-28 to I-29

O-RING: Silicone

SOLDERING PROCESS:

- Surface Mount Terminals: Infrared Reflow Soldering in accordance with IEC 61760-1.

- Non Reverse Thru-Hole Terminals: Lead free single or double wave soldering process according to C&K Procedure PS-LF-001

- Reverse Thru-Hole Terminals: Manual soldering: 3 sec / 350°C. Lead free single wave soldering process can be used but validation of the process must be done by customer

**Note:** Specifications and materials listed above are for switches with standard options. For information on specific and custom switches, consult Customer Service Center.

## How To Order

The Build-A Switch concept allows you to mix and match options to create the switch you need. Below is a complete listing of options shown in catalog. To order, simply select desired option from each category and place in the appropriate box.

**NOTE:** Some of the configurations may not be available or could require some development.



Number of Positions

- RTE04**    **ESD Protection and top plate**
- RTE10**    **0** Without ESD - standard plate
- RTE16**    **1** With ESD - standard plate <sup>2</sup>
- B** Without ESD - black plate

- Actuator**
- 0** Flush, screwdriver slot
- 2** Shaft for button

- Terminations**
- N** Thru-hole
- V** Right angle
- G** Surface mount
- R** Reverse, thru-hole

- Contact/Terminal Material**
- 4** Gold 0.5  $\mu$ m/ Lead free tin
- 7** Gold 1.0  $\mu$ m/ Gold

- Switch Function**
- 0** Single pole <sup>1</sup>
- 1** BCD code
- 3** Gray Code (for RTE 10)
- 4** Hexadecimal code (for RTE 16)
- 7** Gray Code (for RTE 16)



1 - Single pole function not available for RTE10/RTE16  
2 - ESD protection available with "N" and "R" terminations only

# RTE Series Low Profile Rotary DIP Switches

## SWITCHES WITH STANDARD OPTIONS

### PC Mount-Terminal Option N

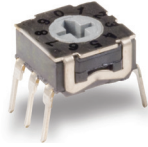

### Right Angle Mount-Terminal Option V

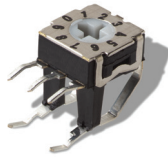

### Surface Mount-Terminal Option G

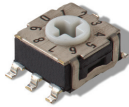

## NUMBER OF POSITIONS

### RTE04 4 POSITIONS

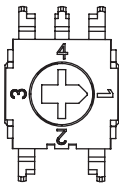

### RTE10 10 POSITIONS

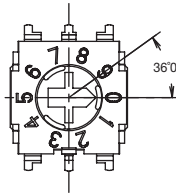

### RTE16 16 POSITIONS

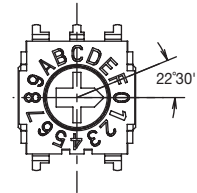

# RTE Series Low Profile Rotary DIP Switches



H

DIP

## ESD PROTECTION

0 WITHOUT

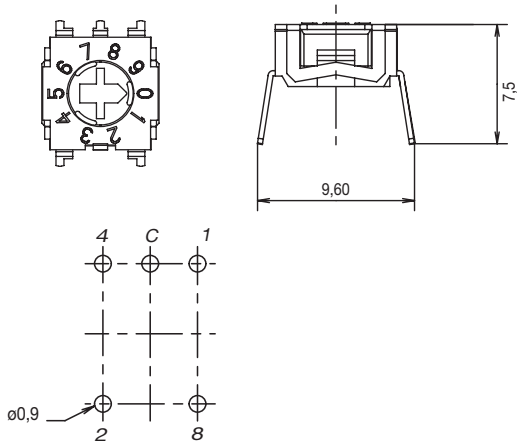

1 WITH

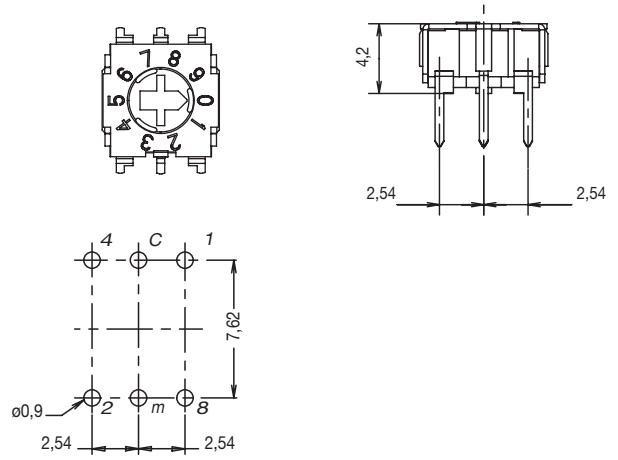

## ACTUATOR

0 SCREWDRIVER SLOT

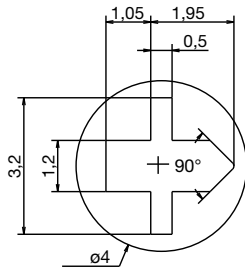

For non-SMT Terminations (N, V or R option)

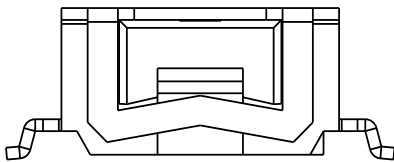

For SMT Termination Only (G option)

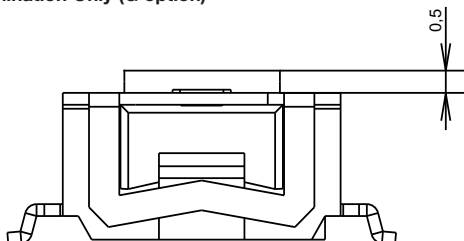

2 SHAFT FOR BUTTON

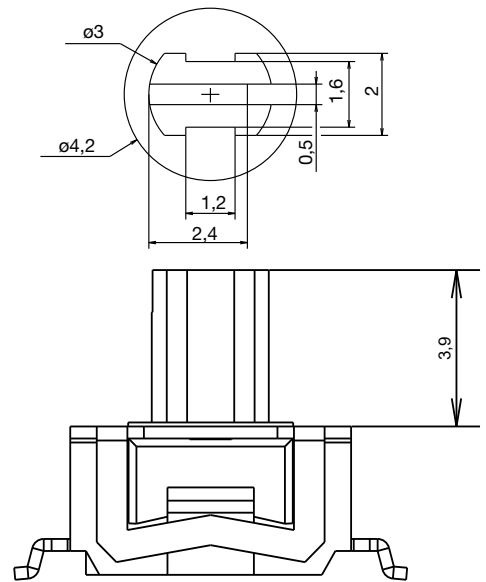

First Angle  
Projection

Dimensions are shown: Inch (mm)  
Specifications and dimensions subject to change

# RTE Series Low Profile Rotary DIP Switches

## TERMINATIONS



DIP I

### N THRU-HOLE

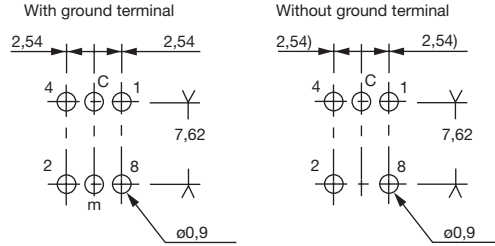
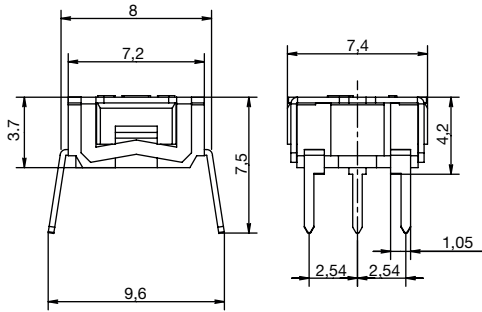

### R REVERSE, THRU-HOLE

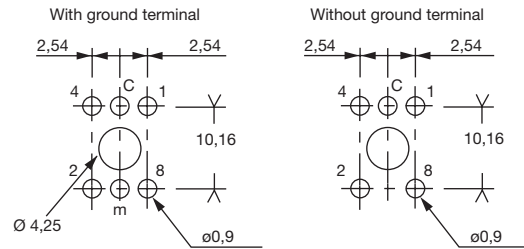
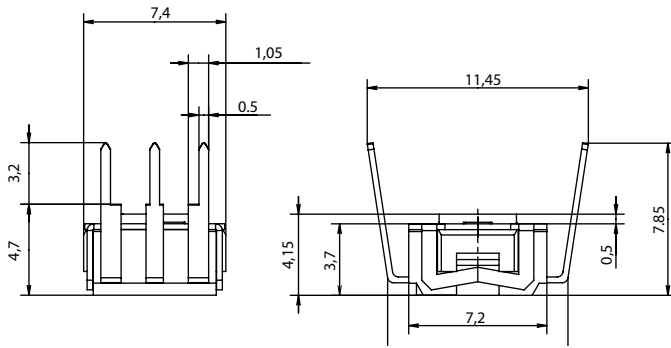

### V RIGHT ANGLE, THRU-HOLE

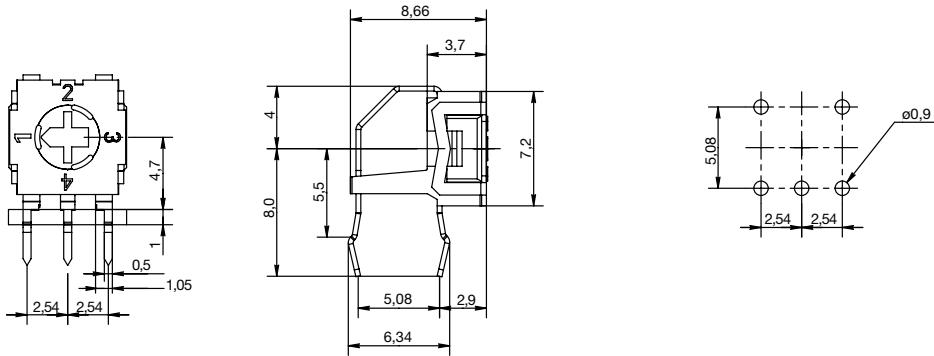

### G SURFACE MOUNT

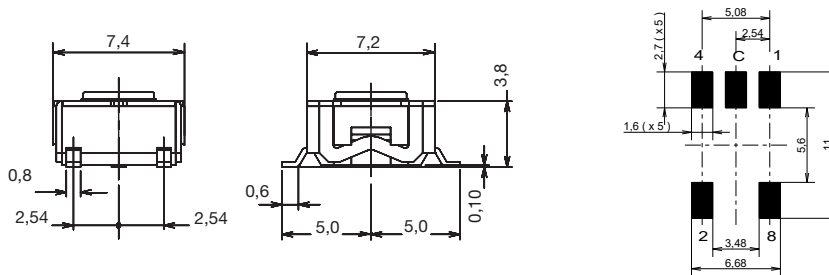

PCB layout seen component side



Dimensions are shown: Inch (mm)  
Specifications and dimensions subject to change

## SWITCH FUNCTION

### 0 SINGLE POLE

POS.	1	2	3	4
C	●	●	●	●
1	●			
2		●		
3			●	
4				●

### 1 BCD CODE

POS.	0	1	2	3	4	5	6	7	8	9
C	●	●	●	●	●	●	●	●	●	●
1		●						●		●
2			●	●			●	●		
4					●	●	●	●		
8									●	●

### 3 GRAY CODE ( for RTE10 only )

POS.	0	1	2	3	4	5	6	7	8	9
C	●	●	●	●	●	●	●	●	●	●
1		●	●			●	●			●
2			●	●	●	●				
4				●	●	●	●	●	●	●
8									●	●

### 4 HEXADECIMAL CODE

POS.	0	1	2	3	4	5	6	7	8	9	A	B	C	D	E	F
C	●	●	●	●	●	●	●	●	●	●	●	●	●	●	●	●
1		●				●	●		●		●		●		●	
2			●	●			●	●			●		●		●	
4					●	●	●	●				●	●	●	●	
8									●	●	●	●	●	●	●	

### 7 GRAY CODE (for RTE04 only)

POS.	1	2	3	4
C	●	●	●	●
1	●			
2		●		
4			●	
8				●

(for RTE16 only)

POS.	0	1	2	3	4	5	6	7	8	9	A	B	C	D	E	F
C	●	●	●	●	●	●	●	●	●	●	●	●	●	●	●	●
1		●	●						●	●		●		●		●
2			●	●	●	●					●	●	●	●		
4					●	●	●	●	●	●	●	●	●	●	●	●
8									●	●	●	●	●	●	●	●

## CONTACT MATERIAL

OPTION CODE	CONTACT MATERIAL	TERMINAL PLATING
4	Gold: 0.5 $\mu$ m	Lead Free Tin
7	Gold: 1 $\mu$ m	Gold



First Angle  
Projection

Dimensions are shown: Inch (mm)  
Specifications and dimensions subject to change



# RTF Series 7.2mm x 7.2mm Low Profile Rotary DIP Switches



H

DIP

## Features/Benefits

- **New generation**
- **Most compact rotary DIP switch**
- **Thru-hole, Crimped, J-Bend, Angled and Surface Mount Models**
- **New designs with different actuators**
- **IP67**
- **RoHS compatible and compliant**

## Typical Applications

- **Industrial and control automation**
- **Automotive**
- **Computer and peripherals**
- **Instrumentation**
- **Security devices**

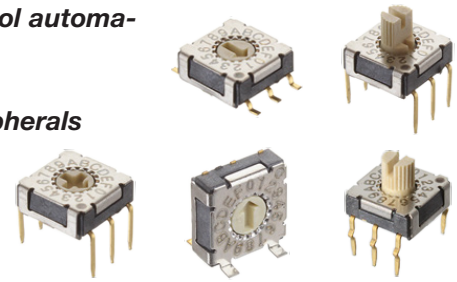

## Specifications

CONTACT RATING: 100mA, DC 5V (switching)  
100mA, DC 50V (non-switching)

MECHANICAL & ELECTRICAL LIFE: 10,000 cycles  
INITIAL CONTACT RESISTANCE: 100 milliohms max.  
INSULATION RESISTANCE: 100 megohms min.  
OPERATING TEMPERATURE: -40°C to 85°C.  
STORAGE TEMPERATURE: -40°C to 85°C.  
OPERATING FORCE: 200 gf max.

### SOLDER CONDITIONS:

- Iron soldering: C/K/S/A/J termination: 3s/350°C
- Wave soldering: C/K/A termination: 5s/280°C
- Reflow soldering: S/J termination: 10s/260°C

SOLDERABILITY: Dip and look solderability testing per C&K spec #448

PACKAGING: Switches are supplied in rigid dispensing tubes in full-tube quantities only, this may affect order quantities. Number of switches per tube varies with model. Tape and reel packing is only available with "S" and "J" type terminations.

## Materials

COVER: Stainless steel  
BASE: LCP  
ACTUATOR: LCP  
CONTACTS: Phosphor bronze, gold plated  
SPRING & GUIDE PLATE: Stainless steel  
TERMINALS: Brass, gold plated  
O-RING: Silicon

## How To Order

The Build-A Switch concept allows you to mix and match options to create the switch you need. Below is a complete listing of options shown in catalog. To order, simply select desired option from each category and place in the appropriate box.

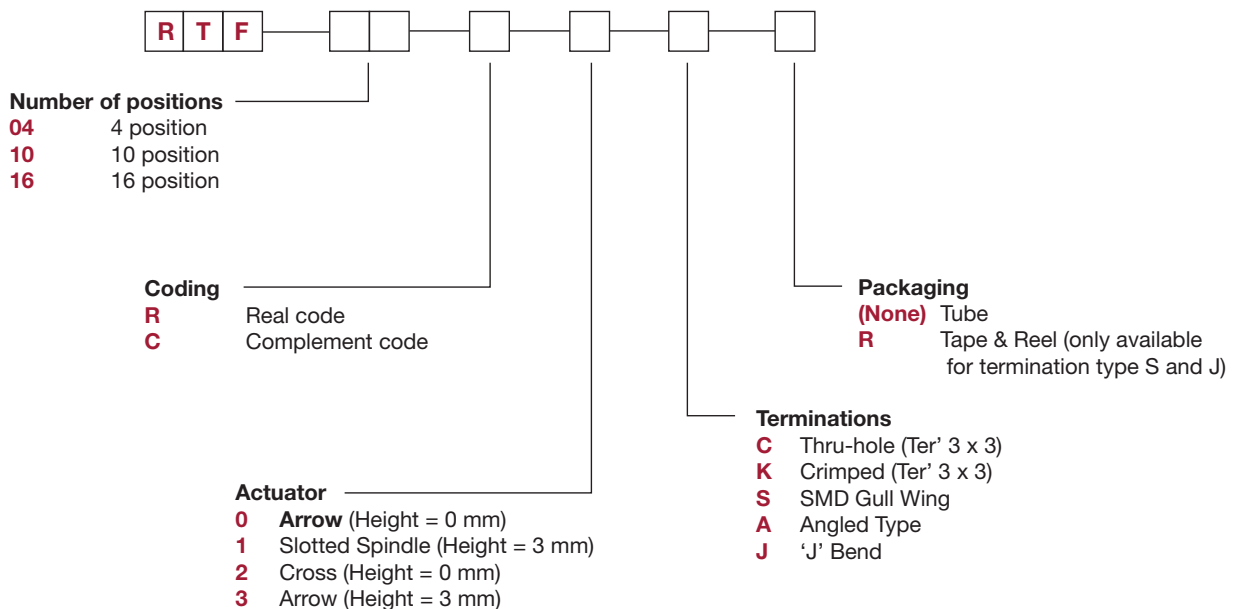

Dimensions are shown: Inch (mm)  
Specifications and dimensions subject to change



# RTF Series

## 7.2mm x 7.2mm Low Profile Rotary DIP Switches

### CODING

#### R Real Code

04 POSITION

		Real Code				
		C	1	2	4	8
04 POSITION	0	●				
	1	●	●			
	2	●	●	●		
	3	●	●	●	●	

10 POSITION

		Real Code				
		C	1	2	4	8
10 POSITION	0	●				
	1	●	●			
	2	●	●	●		
	3	●	●	●	●	
	4	●	●	●	●	●
	5	●	●	●	●	●
	6	●	●	●	●	●
	7	●	●	●	●	●
	8	●	●	●	●	●
	9	●	●	●	●	●

16 POSITION

		Real Code				
		C	1	2	4	8
16 POSITION	0	●				
	1	●	●			
	2	●	●	●		
	3	●	●	●	●	
	4	●	●	●	●	●
	5	●	●	●	●	●
	6	●	●	●	●	●
	7	●	●	●	●	●
	8	●	●	●	●	●
	9	●	●	●	●	●
	A	●	●	●	●	●
	B	●	●	●	●	●
	C	●	●	●	●	●
	D	●	●	●	●	●
	E	●	●	●	●	●
	F	●	●	●	●	●

#### C Complement Code

04 POSITION

		Complement Code				
		C	1	2	4	8
04 POSITION	0		●			
	1			●		
	2				●	
	3					●

10 POSITION

		Complement Code				
		C	1	2	4	8
10 POSITION	0		●			
	1			●		
	2				●	
	3					●
	4		●	●		
	5		●	●	●	
	6		●	●	●	●
	7		●	●	●	●
	8		●	●	●	●
	9		●	●	●	●

16 POSITION

		Complement Code				
		C	1	2	4	8
16 POSITION	0		●			
	1			●		
	2				●	
	3					●
	4		●	●		
	5		●	●	●	
	6		●	●	●	●
	7		●	●	●	●
	8		●	●	●	●
	9		●	●	●	●
	A		●	●	●	●
	B		●	●	●	●
	C		●	●	●	●
	D		●	●	●	●
	E		●	●	●	●
	F		●	●	●	●

### ACTUATOR

#### 0 Arrow (Height = 0 mm)

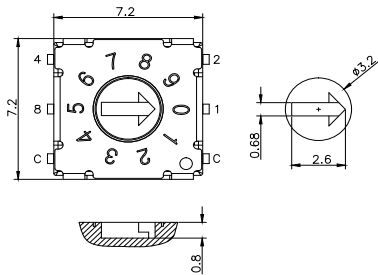

#### 1 Slotted Spindle (Height = 3 mm)

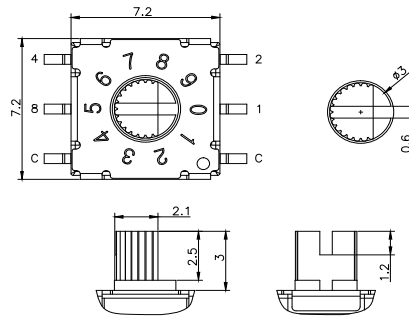

#### 2 Cross (Height = 0 mm)

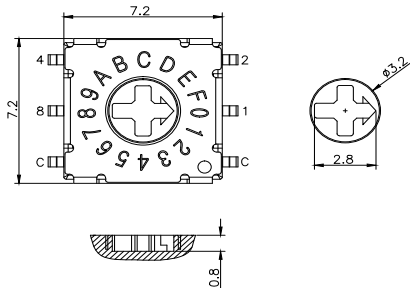

#### 3 Arrow (Height = 3 mm)

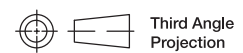
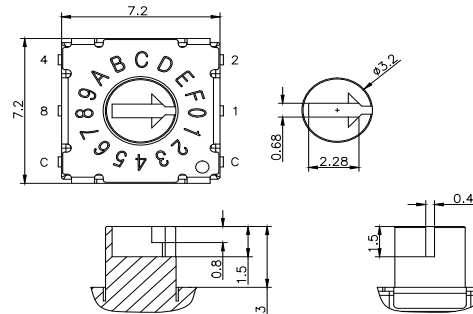

Dimensions are shown: Inch (mm)  
Specifications and dimensions subject to change

# RTF Series 7.2mm x 7.2mm Low Profile Rotary DIP Switches

## TERMINATIONS

### C Thru-hole

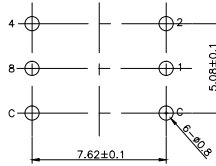
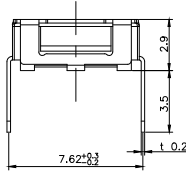
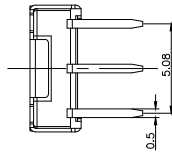
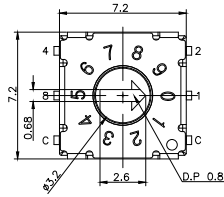

P.C.B DIMENSION

### K Crimped (Ter' 3 x 3)

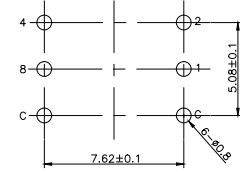
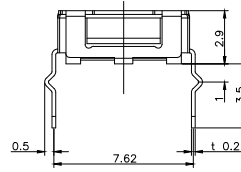
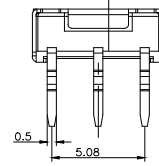
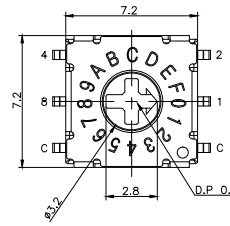

P.C.B DIMENSION

### S SMD Gull Wing

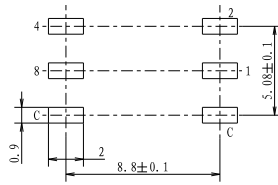
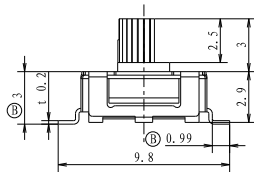
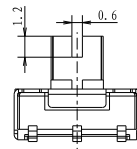
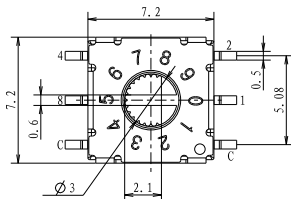

P. C. B DIMENSION

### J Bend SMD

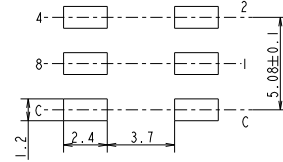
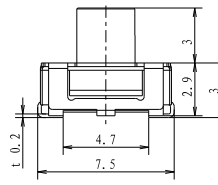
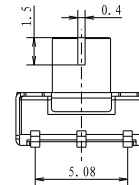
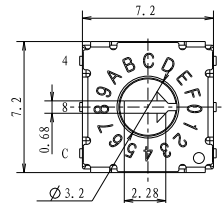

P. C. B DIMENSION

### A Angled Type

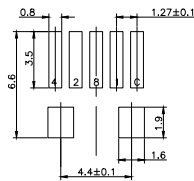
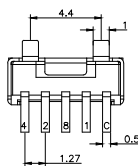
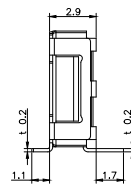
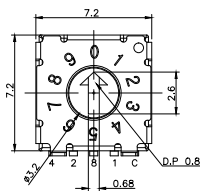

P.C.B DIMENSION

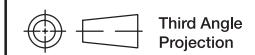

Third Angle  
Projection

Dimensions are shown: Inch (mm)  
Specifications and dimensions subject to change

# RTF Series

## 7.2mm x 7.2mm Low Profile Rotary DIP Switches

### TAPE & REEL

DIP

The tape and reel is applicable for  
 Actuator 0 or 2 with  
 Termination S or J  
 1300 pcs/reel

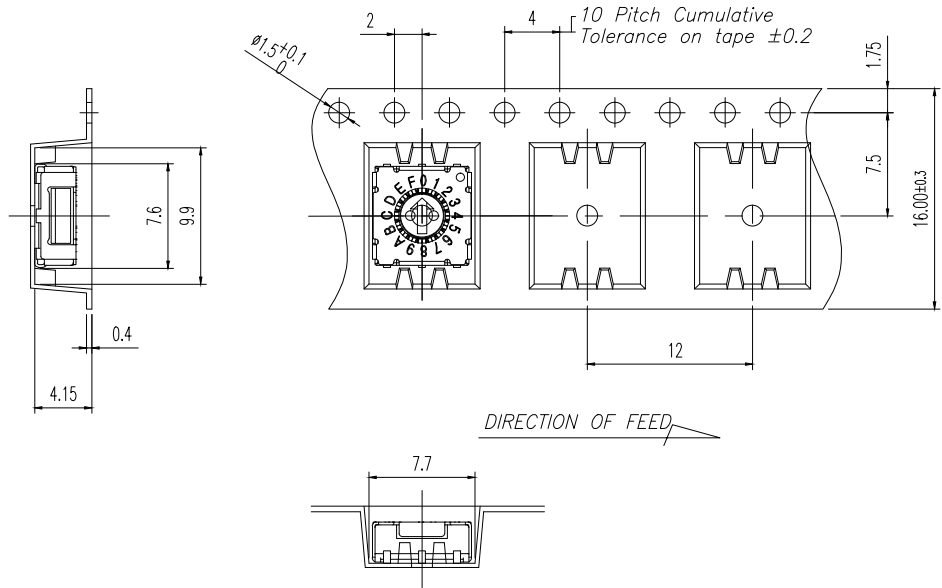

The tape and reel is applicable for  
 Actuator 1 or 3 with  
 Termination S or J  
 800 pcs/reel

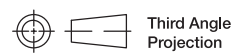
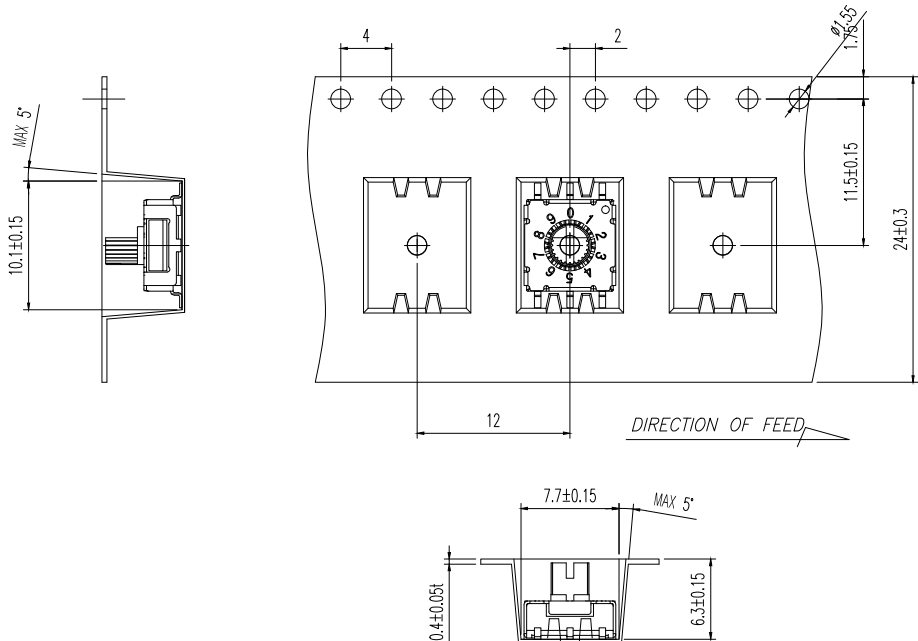

Dimensions are shown: Inch (mm)  
 Specifications and dimensions subject to change

# CD Series 8mm DIP Coded Rotary Switches



H

DIP

## Features/Benefits

- **Process sealed – withstands soldering and cleaning**
- **Thru-hole and surface mount models**
- **Compact size saves space – 36% smaller than traditional 10mm DIP**
- **Crisp, positive detent ensures actuation**
- **RoHS compliant**
- **IP65**

## Typical Applications

- **Address switching applications**
- **Data storage devices**
- **Computer and peripherals**
- **Instrumentation**



## Specifications

CONTACT RATING: 0.4 VA max. @ 20 V AC or V DC max.

MECHANICAL AND ELECTRICAL LIFE:

CD10 & CD16: 20,000 actuations.

CD08: 12,000 actuations.

CONTACT RESISTANCE: 50 milliohms max. initial.

INSULATION RESISTANCE: 100 megohms min.

@ 250 V AC min.

DIELECTRIC STRENGTH: 250 V RMS min. @ sea level.

OPERATING TEMPERATURE: -25°C to 85°C.

STORAGE TEMPERATURE: -40°C to 85°C.

SOLDERABILITY: Per MIL-STD-202F method 208D or EIA RS-186E, method 9 (1 hour steam aging).

PACKAGING: Switches supplied in rigid tubes in full-tube quantities only: this may affect order quantity. Tube quantity is 60 pieces per tube. Surface mount switches available in tape & reel packaging per EIA 481A, 800 per reel, surface mount with “M0” actuator only.

## Materials

COVER: PPS (UL94V-0), Color; Black.

BASE: PPS (UL94V-0), Color; Black

ACTUATOR: LCP (UL 94V-0), Color White (CDXXR)  
Color Black (CDXXC)

Note: internal o-ring seal standard with all actuators.

MOVABLE CONTACTS: Copper alloy with gold plate over nickel plate.

STATIONARY CONTACTS: Copper alloy with gold plate over nickel plate.

TERMINALS: Copper alloy with gold plate over nickel plate.

**Note:** Specifications and materials listed above are for switches with standard options. For information on specific and custom switches, consult Customer Service Center.

## How To Order

The Build-A Switch concept allows you to mix and match options to create the switch you need. Below is a complete listing of options shown in catalog. To order, simply select desired option from each category and place in the appropriate box.

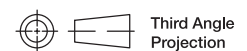
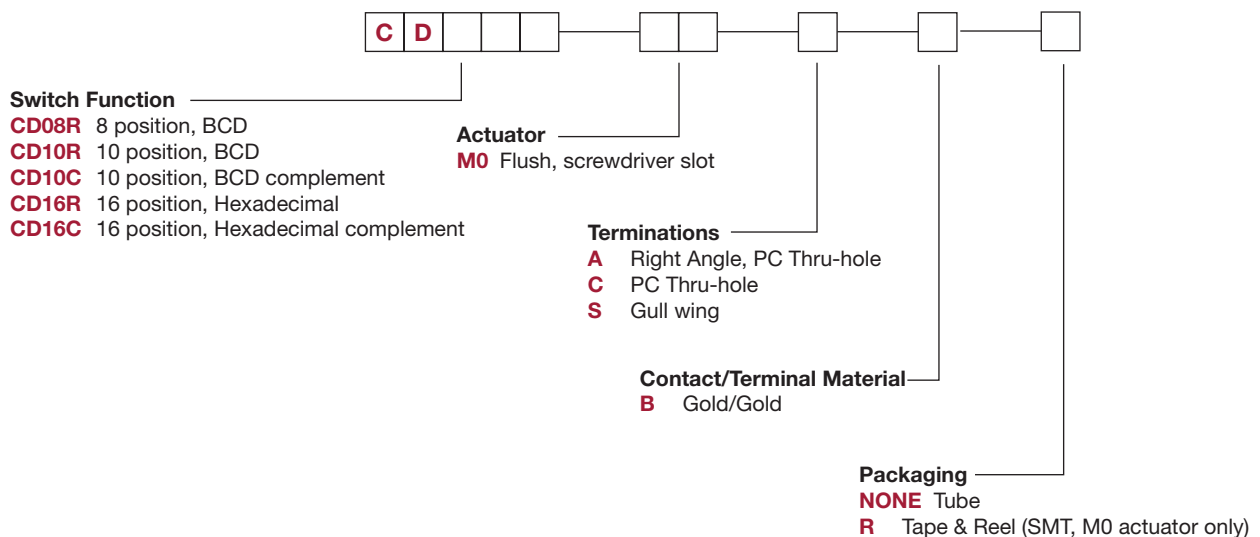

Dimensions are shown: Inch (mm)  
Specifications and dimensions subject to change

# CD Series 8mm DIP Coded Rotary Switches

## SWITCHES WITH STANDARD OPTIONS

### PC Mount



CD16RM0CB

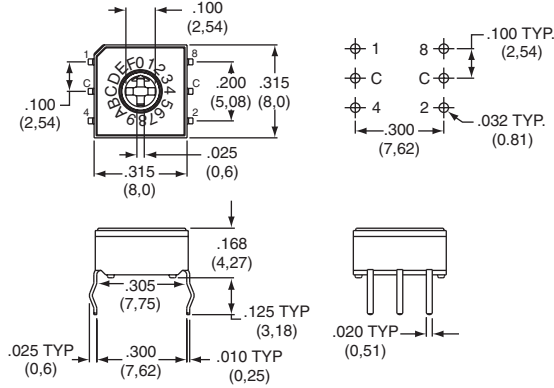

PART NUMBER	NO. POS.	QUANTITY PER TUBE
CD08RM0CB	8	60
CD10RM0CB	10	60
CD10CM0CB	10	60
CD16RM0CB	16	60
CD16CM0CB	16	60

### Right Angle Mount



CD10RM0AB

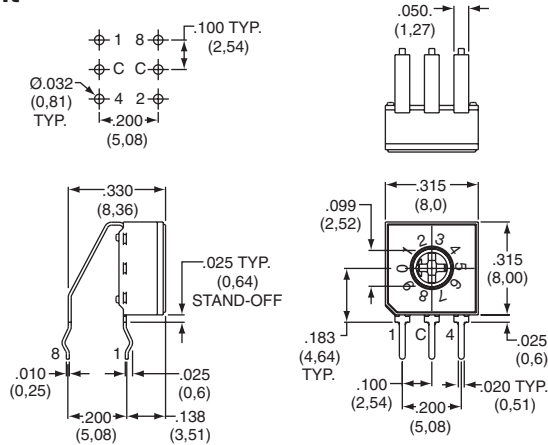

PART NUMBER	NO. POS.	QUANTITY PER TUBE
CD08RM0AB	8	60
CD10RM0AB	10	60
CD10CM0AB	10	60
CD16RM0AB	16	60
CD16CM0AB	16	60

### Surface Mount



CD10RM0SB

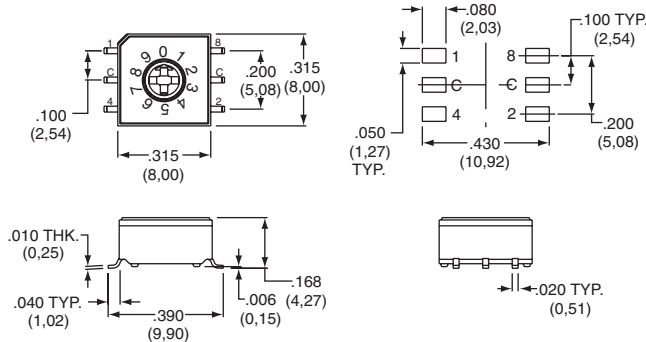

PART NUMBER	NO. POS.	QUANTITY PER TUBE
CD08RM0SB	8	60
CD10RM0SB	10	60
CD10CM0SB	10	60
CD16RM0SB	16	60
CD16CM0SB	16	60

Note: For tape and reel packaging, add 'R' to end of part number.

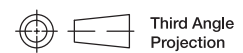

Dimensions are shown: Inch (mm)  
Specifications and dimensions subject to change

# CD Series 8mm DIP Coded Rotary Switches



H

DIP

## SWITCH FUNCTION

**CD08R** 8 POSITION, BCD  
ACTUATOR COLOR: WHITE

POS.	0	1	2	3	4	5	6	7
C	●	●	●	●	●	●	●	●
1		●						
2			●	●			●	●
4					●	●	●	●
8								

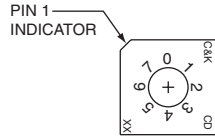

Switches ship and to be solder processed in position "0"

**CD10R** 10 POSITION, BCD  
ACTUATOR COLOR: WHITE

POS.	0	1	2	3	4	5	6	7	8	9
C	●	●	●	●	●	●	●	●	●	●
1		●		●		●		●		●
2			●	●			●	●		
4					●	●	●	●		
8									●	●

Switches ship and to be solder processed in position "0"

**CD10C** 10 POSITION, BCD COMPLEMENT  
ACTUATOR COLOR: BLACK

POS.	0	1	2	3	4	5	6	7	8	9
C	●	●	●	●	●	●	●	●	●	●
1	●		●		●		●		●	
2	●	●			●	●			●	●
4	●				●	●	●		●	●
8	●	●	●	●	●	●	●	●	●	●

Switches ship and to be solder processed in position "7"

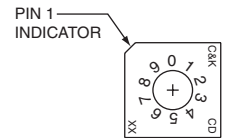

**CD16R** 16 POSITION, HEXADECIMAL  
ACTUATOR COLOR: WHITE

POS.	0	1	2	3	4	5	6	7	8	9	A	B	C	D	E	F
C	●	●	●	●	●	●	●	●	●	●	●	●	●	●	●	●
1		●		●		●		●		●		●		●		●
2			●	●			●	●			●	●			●	●
4					●	●	●	●			●	●	●	●		
8									●	●	●	●	●	●	●	●

Switches ship and to be solder processed in position "0"

**CD16C** 16 POSITION, HEXADECIMAL COMPLEMENT  
ACTUATOR COLOR: BLACK

POS.	0	1	2	3	4	5	6	7	8	9	A	B	C	D	E	F
C	●	●	●	●	●	●	●	●	●	●	●	●	●	●	●	●
1	●		●		●		●		●		●		●		●	
2	●	●			●	●			●	●			●	●		
4	●				●	●	●	●			●	●	●	●		
8	●	●	●	●	●	●	●	●	●	●	●	●	●	●	●	●

Switches ship and to be solder processed in position "F"

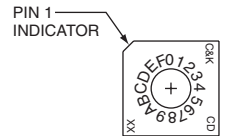

## ACTUATOR

**M0** (STD.) FLUSH WITH SCREWDRIVER SLOT

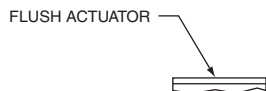
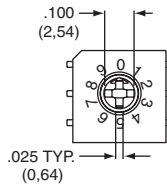

NOTE: Designed for #0 Phillips screwdriver.

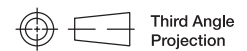

Dimensions are shown: Inch (mm)  
Specifications and dimensions subject to change



12 Nov 20

# CD Series 8mm DIP Coded Rotary Switches

## TERMINATIONS



### C PC, THRU-HOLE

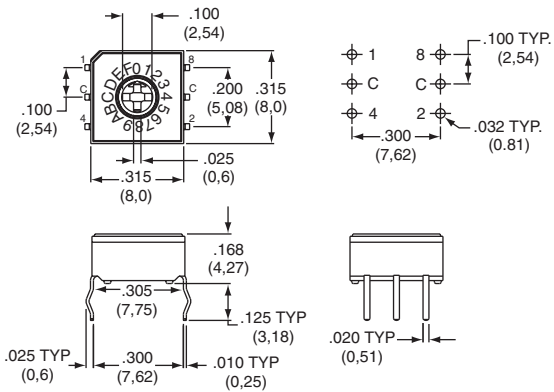

### A RIGHT ANGLE, PC THRU-HOLE

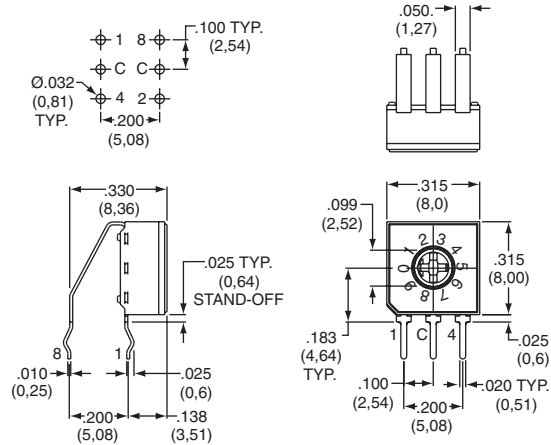

### S SURFACE MOUNT

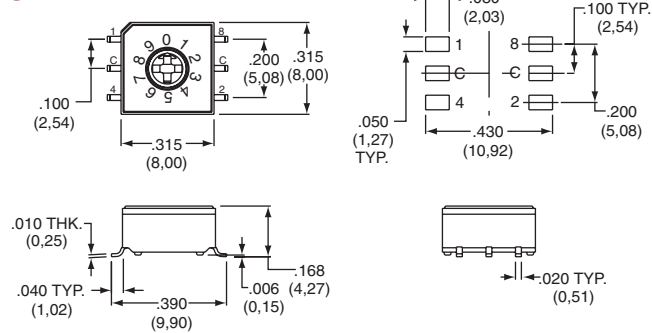

## CONTACT MATERIAL



OPTION CODE	RoHS COMPLIANT*	RoHS COMPATIBLE*	CONTACT MATERIAL	TERMINAL PLATING	RATING	
<b>B</b>	YES	YES	GOLD	GOLD	LOW LEVEL/DRY CIRCUIT	0.4 VC MAX. @ 20 V AC or DC MAX.

\* Note: See Technical Data section of this catalog for RoHS compliant and compatible definitions and specifications.

## TAPE & REEL

For part number CDxxM0SB

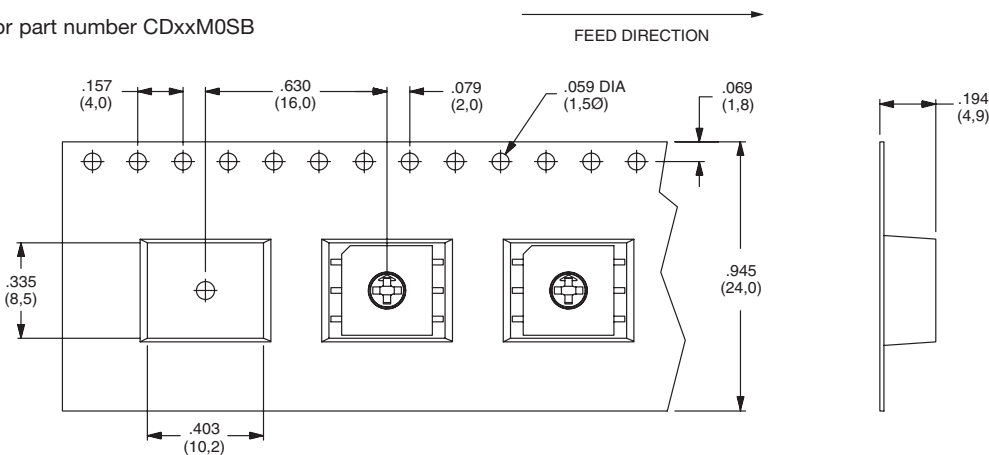

### Reel Information

Outside diameter 13.00 (333,0)  
Pilot hole .512 (13,0)

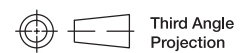

Third Angle Projection

# CRD Series 10mm DIP Coded Rotary Switches



H

DIP

## Features/Benefits

- Process sealed – withstands soldering and cleaning
- Thru-hole and surface mount models
- Crisp, positive detent ensures actuation
- Computer and peripherals
- RoHS compliant
- IP65

## Typical Applications

- Address switching applications
- Data storage devices
- Computer and peripherals
- Instrumentation

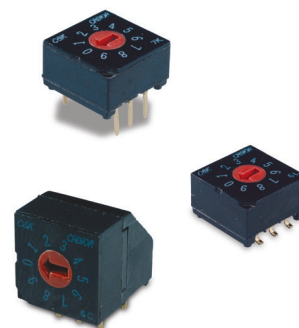

## Specifications

CONTACT RATING: 0.4 V AC, DC 20 V max.  
 ELECTRICAL LIFE: 20,000 steps min. @ 5 V DC 10 mA.  
 MECHANICAL LIFE: 30,000 steps min.  
 CONTACT RESISTANCE: 100 milliohms max. initial @ 2 V DC 10 mA.  
 INSULATION RESISTANCE: 1000 megohms min. @ 100 V DC  
 DIELECTRIC STRENGTH: 300 V AC for 1 minute.  
 OPERATING TEMPERATURE: -20°C to 85°C.  
 STORAGE TEMPERATURE: -40°C to 85°C.  
 OPERATING FORCE: 1000 grams max.  
 PACKAGING: Switches supplied in anti-static tubes in full quantities only. This may affect order quantity. Surface mount models with MO actuators available in tape and reel, 500 pieces per reel.

## Materials

COVER: PPS (black)  
 HOUSING: PPS (black)  
 ACTUATOR: PA 6T M0 actuator option; PBT L1 and W1 actuator option.  
 CONTACTS: Beryllium Copper with Gold over Nickel plate  
 TERMINALS: Brass with Gold Nickel plate.

**Note:** Specifications and materials listed above are for switches with standard options. For information on specific and custom switches, consult Customer Service Center.

## How To Order

The Build-A Switch concept allows you to mix and match options to create the switch you need. Below is a complete listing of options shown in catalog. To order, simply select desired option from each category and place in the appropriate box.

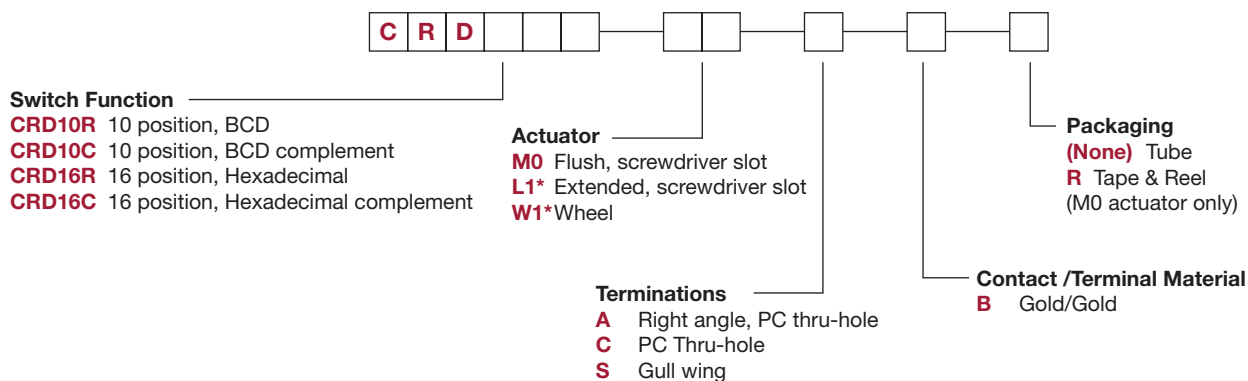

\* Note - L1 & W1 actuators are available for terminations A & C and switch functions CRD16R & CRD16C  
 - L1 & W1 actuators are not available for termination S and switch functions CRD10R & CRD10C



Dimensions are shown: Inch (mm)  
 Specifications and dimensions subject to change



# CRD Series 10mm DIP Coded Rotary Switches

## SWITCHES WITH STANDARD OPTIONS

### PC Mount

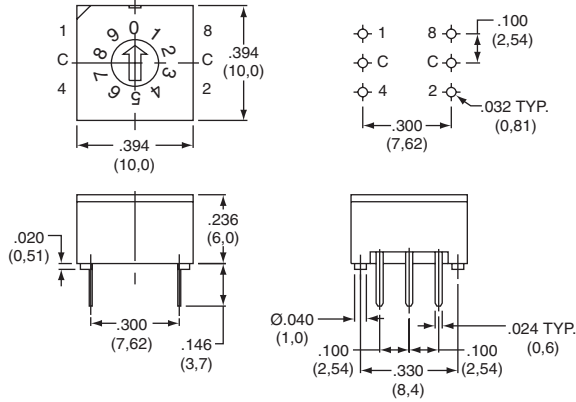
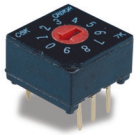

PART NUMBER	NO. POS.	QUANTITY PER TUBE
<b>CRD10RM0CB</b>	10	45
<b>CRD16RM0CB</b>	16	45

### Right Angle Mount

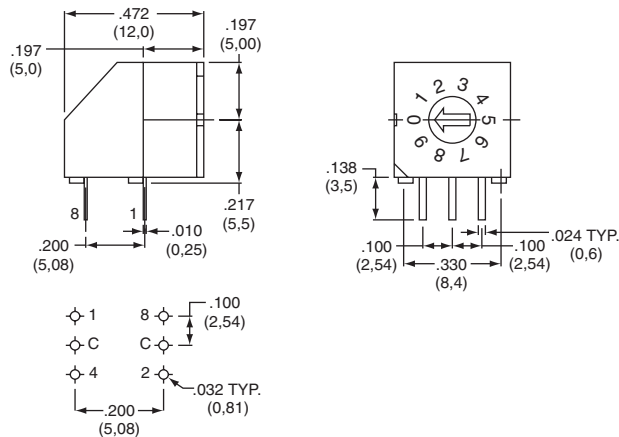

PART NUMBER	NO. POS.	QUANTITY PER TUBE
<b>CRD10RM0AB</b>	10	45
<b>CRD16RM0AB</b>	16	45

### Surface Mount

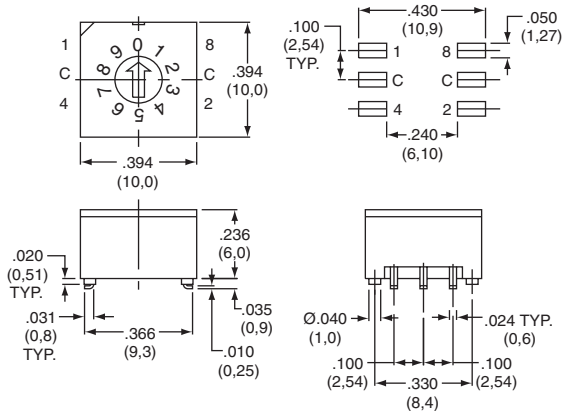

PART NUMBER	NO. POS.	QUANTITY PER TUBE
<b>CRD10RM0SB</b>	10	45
<b>CRD16RM0SB</b>	16	45

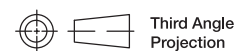

Third Angle Projection  
Dimensions are shown: Inch (mm)  
Specifications and dimensions subject to change

# CRD Series 10mm DIP Coded Rotary Switches

## SWITCH FUNCTION



H

DIP

### CRD10R

10 POSITION, BCD  
ACTUATOR COLOR: RED

POS.	0	1	2	3	4	5	6	7	8	9
C	●	●	●	●	●	●	●	●	●	●
1		●					●		●	●
2			●					●		●
4					●	●	●			
8									●	●

Switches ship and to be solder processed in position "0"

### CRD10C

10 POSITION, BCD COMPLEMENT  
ACTUATOR COLOR: ORANGE

POS.	0	1	2	3	4	5	6	7	8	9
C	●	●	●	●	●	●	●	●	●	●
1	●		●		●		●		●	
2	●			●				●		●
4	●	●		●					●	●
8	●	●	●	●	●	●	●	●		

Switches ship and to be solder processed in position "7"

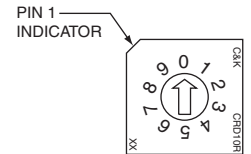

### CRD16R

16 POSITION, HEXADECIMAL  
ACTUATOR COLOR: BLACK

POS.	0	1	2	3	4	5	6	7	8	9	A	B	C	D	E	F
C	●	●	●	●	●	●	●	●	●	●	●	●	●	●	●	●
1		●														
2			●													
4					●	●	●							●	●	●
8									●	●	●	●	●	●	●	●

Switches ship and to be solder processed in position "0"

### CRD16C

16 POSITION, HEXADECIMAL COMPLEMENT  
ACTUATOR COLOR: WHITE

POS.	0	1	2	3	4	5	6	7	8	9	A	B	C	D	E	F
C	●	●	●	●	●	●	●	●	●	●	●	●	●	●	●	●
1	●		●		●		●		●		●		●		●	
2	●			●				●				●		●		●
4	●	●		●					●	●				●	●	
8	●	●	●	●	●	●	●	●								

Switches ship and to be solder processed in position "F"

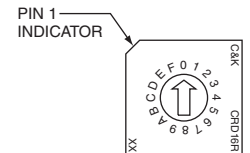

## ACTUATOR



(STD.) FLUSH WITH SCREWDRIVER SLOT

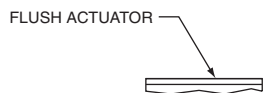
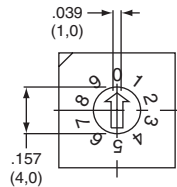

### L1\*

EXTENDED WITH SCREWDRIVER SLOT

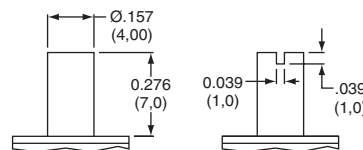
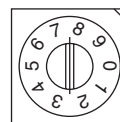

### W1\*

WHEEL

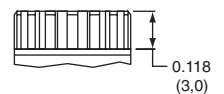

Note: Designed for #0 Phillips screwdriver.

Note: - L1 & W1 actuators are available for terminations A & C and switch functions CRD16R & CRD16C  
- L1 & W1 actuators are not available for termination S and switch functions CRD10R & CRD10C

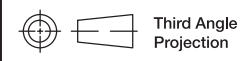

Third Angle  
Projection

Dimensions are shown: Inch (mm)  
Specifications and dimensions subject to change



8 Feb 23

# CRD Series 10mm DIP Coded Rotary Switches

## TERMINATIONS



### C PC, THRU-HOLE

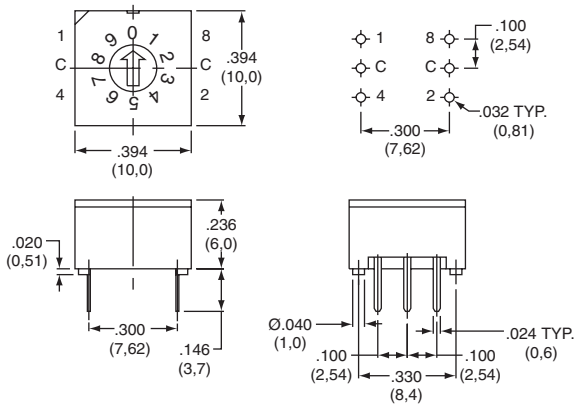

### A RIGHT ANGLE, PC THRU-HOLE

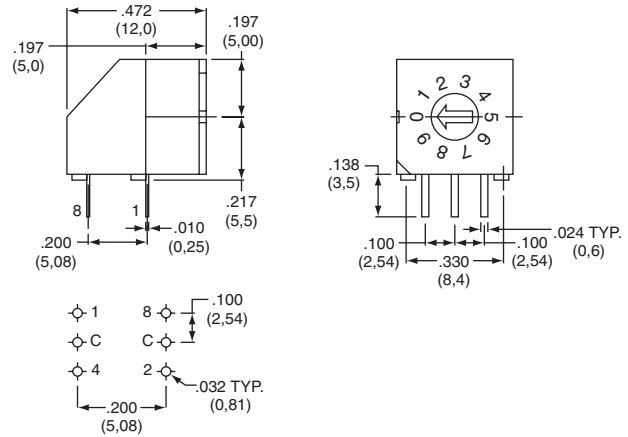

### S SURFACE MOUNT

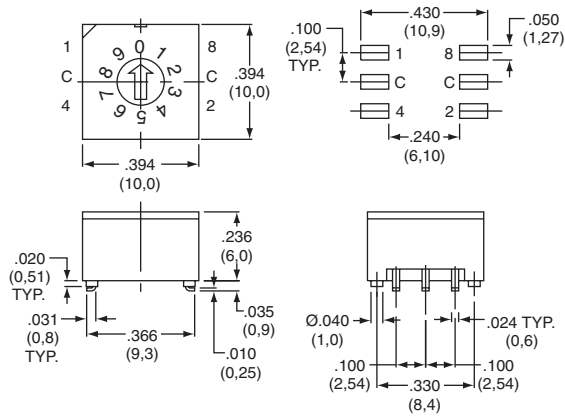

### MO

## CONTACT MATERIAL



OPTION CODE	RoHS COMPLIANT*	RoHS COMPATIBLE*	CONTACT MATERIAL	TERMINAL PLATING	RATING	
<b>B</b>	YES	YES	GOLD	GOLD	LOW LEVEL/DRY CIRCUIT	0.4 VC MAX. @ 20 V AC or DC MAX.

\* Note: See Technical Data section of this catalog for RoHS compliant and compatible definitions and specifications.

## TAPE & REEL

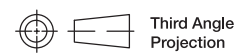
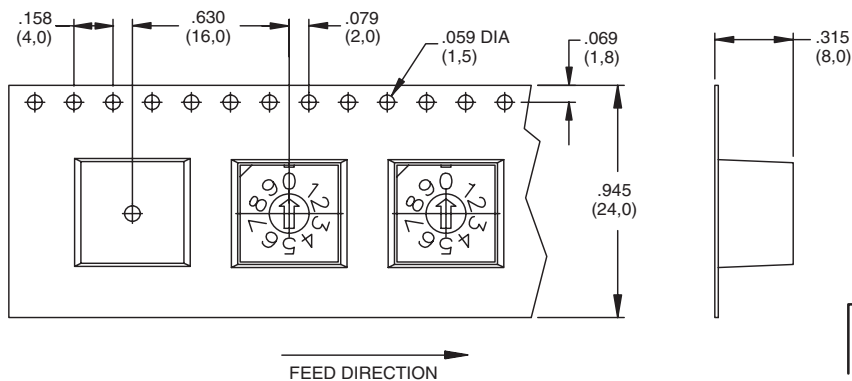

Dimensions are shown: Inch (mm)  
Specifications and dimensions subject to change

# CRE Series 10mm DIP Coded Rotary Switches



H  
DIP

## Features/Benefits

- **Process sealed – withstands soldering and cleaning**
- **Thru-hole and surface mount models**
- **New designs with different actuators**
- **RoHS compatible and compliant**
- **New generation price competitive**
- **IP65**

## Typical Applications

- **Address switching applications**
- **Data storage devices**
- **Computer and peripherals**
- **Instrumentation**

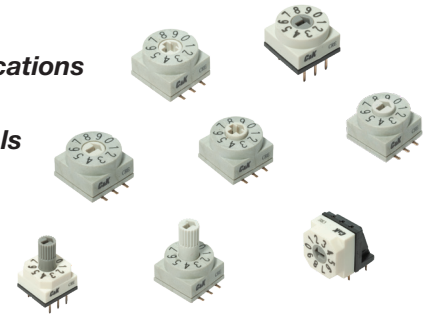

## Specifications

CONTACT RATING: 42 V DC 150mA (switching), 200mA (non-switching)

MECHANICAL & ELECTRICAL LIFE: 10,000 cycles

INITIAL CONTACT RESISTANCE: 200 mΩ max.

INSULATION RESISTANCE: 100 MΩ min.

OPERATING TEMPERATURE: -40°C to 85°C.

STORAGE TEMPERATURE: -40°C to 85°C.

OPERATING FORCE: 700 gf max.

SOLDER CONDITIONS:

- Straight and right-angle types: Iron soldering 2s/340°C, wave soldering 5s/280°C
- Through-hole and SMT types: Iron soldering 2s/340°C, wave soldering: 5s/280°C, reflow soldering 10s/260°C

SOLDERABILITY: Dip and look solderability testing per C&K spec #448

PACKAGING: Switches are supplied in rigid dispensing tubes in full-tube quantities only, this may affect order quantities. Number of switches per tube varies with model. Tape and reel packing also available with exception for the right-angle “A” type terminations.

## Materials

COVER:

- Straight and right-angle types: Nylon#66 (G45%)
- Through-hole and SMT types: LCP (G30%)

BASE:

- Straight and right-angle types: Nylon#66 (G45%)
- Through-hole and SMT types: LCP (G30%)

ACTUATOR:

- Straight and right-angle types: Poly Acetal
- Through-hole and SMT types: Nylon#66 (G45%)

CONTACTS: Brass with Gold nickel plating

TERMINALS: Brass with Gold nickel plating

## How To Order

The Build-A Switch concept allows you to mix and match options to create the switch you need. Below is a complete listing of options shown in catalog. To order, simply select desired option from each category and place in the appropriate box.

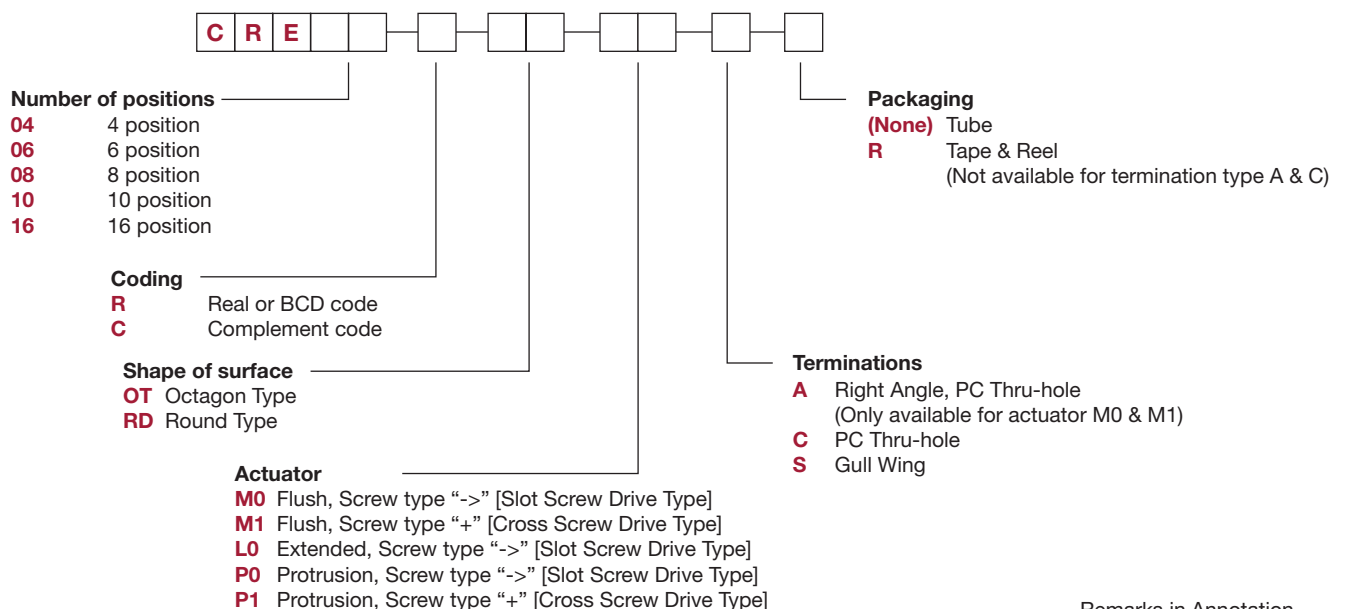

Remarks in Annotation

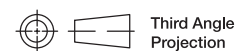

Third Angle  
Projection

# CRE Series 10mm DIP Coded Rotary Switches

## CODING

DIP I

### R Real Code

04 POSITION

		Real Code				
04 POSITION		C	1	2	4	8
0	0	•	•	•	•	•
1	1	•	•	•	•	•
2	2	•	•	•	•	•
3	3	•	•	•	•	•

06 POSITION

		Real Code				
06 POSITION		C	1	2	4	8
0	0	•	•	•	•	•
1	1	•	•	•	•	•
2	2	•	•	•	•	•
3	3	•	•	•	•	•
4	4	•	•	•	•	•
5	5	•	•	•	•	•
6	6	•	•	•	•	•
7	7	•	•	•	•	•

08 POSITION

		Real Code				
08 POSITION		C	1	2	4	8
0	0	•	•	•	•	•
1	1	•	•	•	•	•
2	2	•	•	•	•	•
3	3	•	•	•	•	•
4	4	•	•	•	•	•
5	5	•	•	•	•	•
6	6	•	•	•	•	•
7	7	•	•	•	•	•

10 POSITION

		Real Code				
10 POSITION		C	1	2	4	8
0	0	•	•	•	•	•
1	1	•	•	•	•	•
2	2	•	•	•	•	•
3	3	•	•	•	•	•
4	4	•	•	•	•	•
5	5	•	•	•	•	•
6	6	•	•	•	•	•
7	7	•	•	•	•	•
8	8	•	•	•	•	•
9	9	•	•	•	•	•

16 POSITION

		Real Code				
16 POSITION		C	1	2	4	8
0	0	•	•	•	•	•
1	1	•	•	•	•	•
2	2	•	•	•	•	•
3	3	•	•	•	•	•
4	4	•	•	•	•	•
5	5	•	•	•	•	•
6	6	•	•	•	•	•
7	7	•	•	•	•	•
8	8	•	•	•	•	•
9	9	•	•	•	•	•
A	A	•	•	•	•	•
B	B	•	•	•	•	•
C	C	•	•	•	•	•
D	D	•	•	•	•	•
E	E	•	•	•	•	•
F	F	•	•	•	•	•

PIN 1 INDICATOR

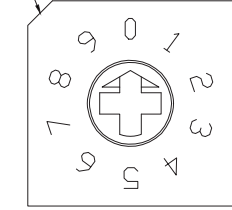

### C Complement Code

04 POSITION

		Complement Code				
04 POSITION		C	1	2	4	8
0	0	•	•	•	•	•
1	1	•	•	•	•	•
2	2	•	•	•	•	•
3	3	•	•	•	•	•

06 POSITION

		Complement Code				
06 POSITION		C	1	2	4	8
0	0	•	•	•	•	•
1	1	•	•	•	•	•
2	2	•	•	•	•	•
3	3	•	•	•	•	•
4	4	•	•	•	•	•
5	5	•	•	•	•	•

08 POSITION

		Complement Code				
08 POSITION		C	1	2	4	8
0	0	•	•	•	•	•
1	1	•	•	•	•	•
2	2	•	•	•	•	•
3	3	•	•	•	•	•
4	4	•	•	•	•	•
5	5	•	•	•	•	•
6	6	•	•	•	•	•
7	7	•	•	•	•	•

10 POSITION

		Complement Code				
10 POSITION		C	1	2	4	8
0	0	•	•	•	•	•
1	1	•	•	•	•	•
2	2	•	•	•	•	•
3	3	•	•	•	•	•
4	4	•	•	•	•	•
5	5	•	•	•	•	•
6	6	•	•	•	•	•
7	7	•	•	•	•	•
8	8	•	•	•	•	•
9	9	•	•	•	•	•

16 POSITION

		Complement Code				
16 POSITION		C	1	2	4	8
0	0	•	•	•	•	•
1	1	•	•	•	•	•
2	2	•	•	•	•	•
3	3	•	•	•	•	•
4	4	•	•	•	•	•
5	5	•	•	•	•	•
6	6	•	•	•	•	•
7	7	•	•	•	•	•
8	8	•	•	•	•	•
9	9	•	•	•	•	•
A	A	•	•	•	•	•
B	B	•	•	•	•	•
C	C	•	•	•	•	•
D	D	•	•	•	•	•
E	E	•	•	•	•	•
F	F	•	•	•	•	•

PIN 1 INDICATOR

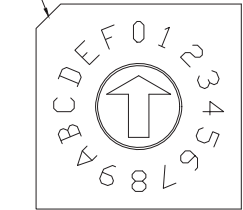

## SHAPE OF SURFACE

### RD Round Type

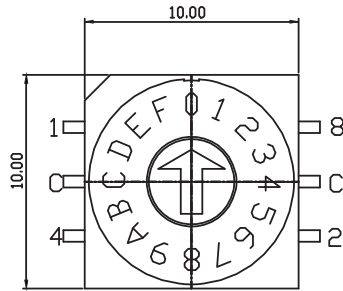

### OT Octagon Type

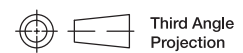
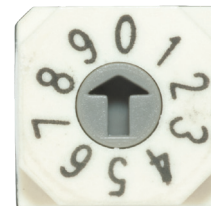
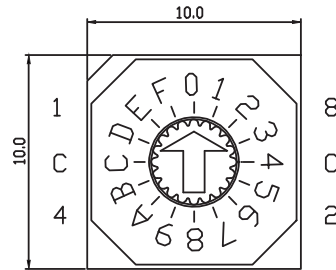

Third Angle Projection

# CRE Series 10mm DIP Coded Rotary Switches



DIP

DIP

## ACTUATOR

**M0** Flush, Screw type “->”

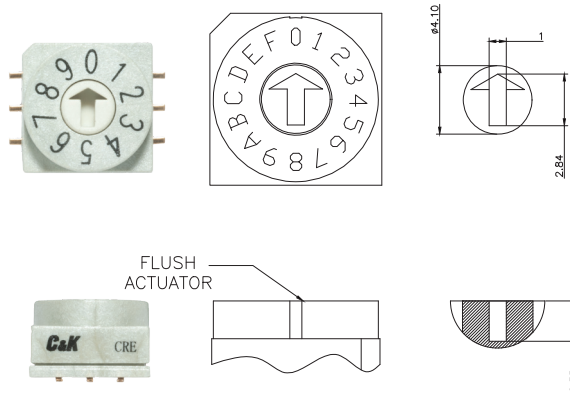

**M1** Flush, Screw type “+”

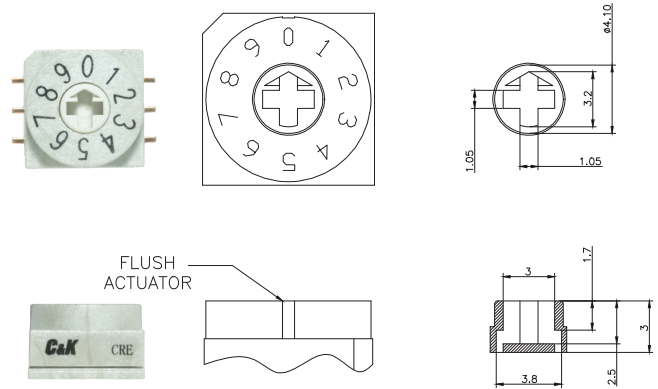

**L0** Extended, Screw type “->”

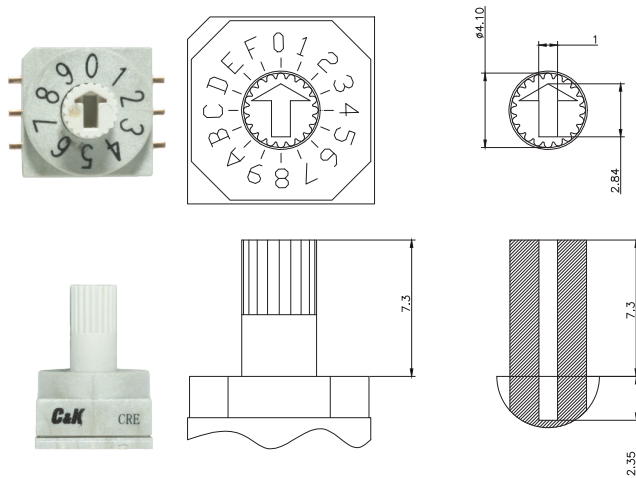

**P0** Protrusion, Screw type “->”

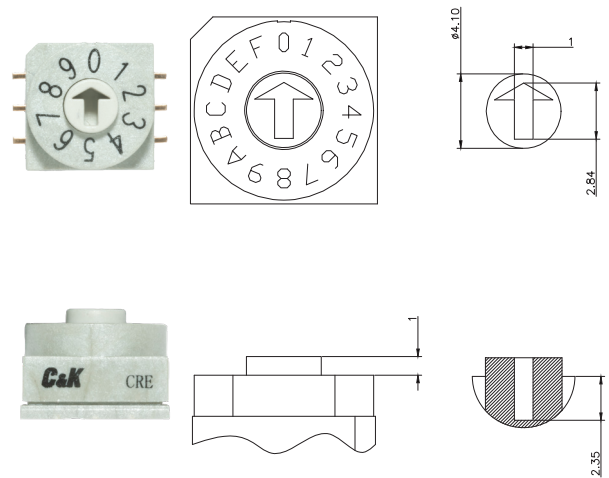

**P1** Protrusion, Screw type “+”

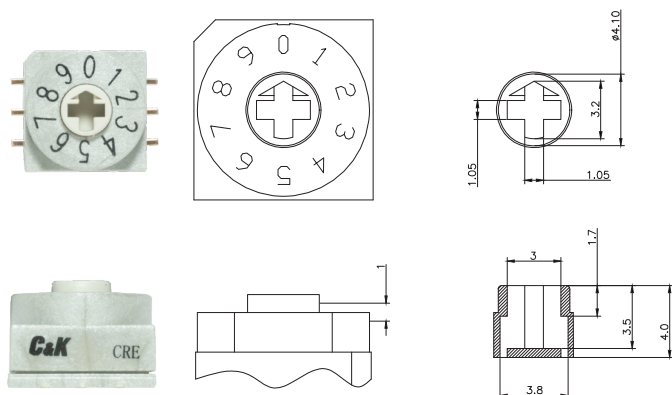

Third Angle  
Projection

Dimensions are shown: Inch (mm)  
Specifications and dimensions subject to change

# CRE Series 10mm DIP Coded Rotary Switches

## TERMINATIONS

### C PC Thru-hole

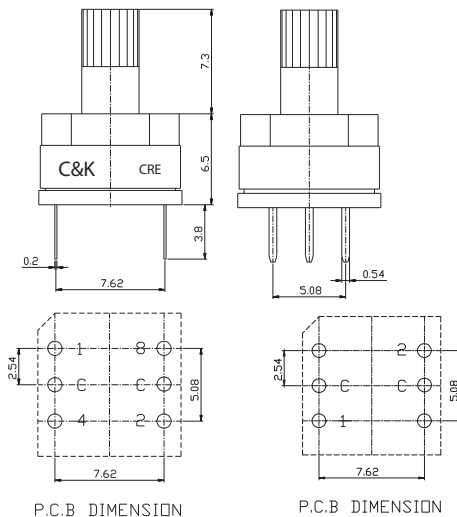

\* For CRE04 only

### S Gull wing

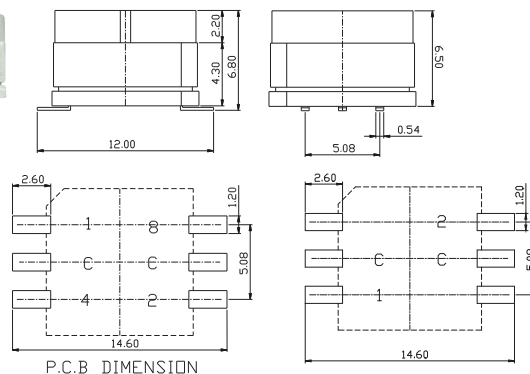

\* For CRE04 only

### A Right Angle Thru-hole

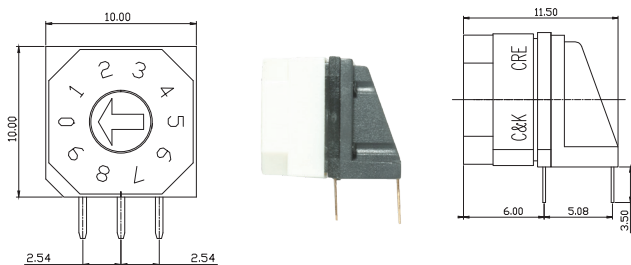
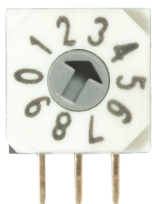

\* For CRE04 only

## TAPE & REEL

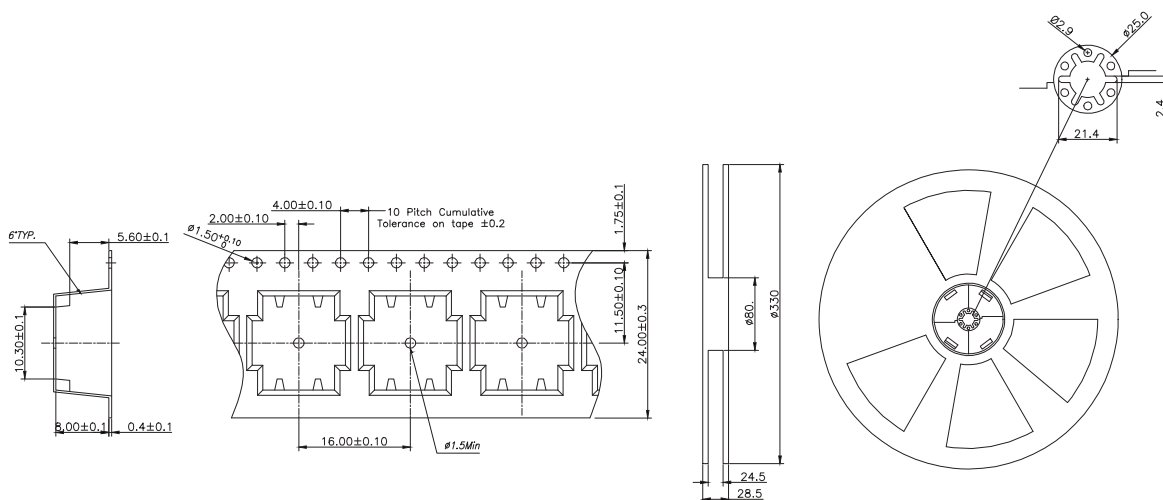

TAPE & REEL: 600 pcs

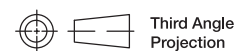

Dimensions are shown: Inch (mm)  
Specifications and dimensions subject to change



3 Dec 21