

Hardware

DRESS NUTS

Switchlocks: Y, H & A Series

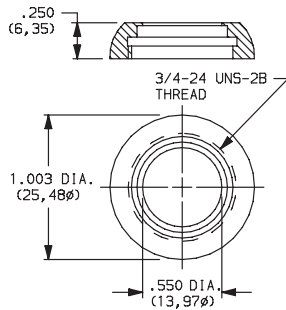

PART NO.
531300201 NICKEL PLATED
175052745 ALUMINIUM BLACK ANODIZE

Toggles: T Series
 Pushbuttons: TP Series

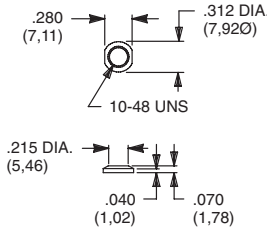

PART NO.
298D01201 NICKEL PLATED
298D01A56 BLACK

Pushbuttons: 8020, 8060, 8500 & TP Series

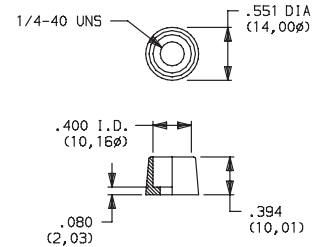

PART NO.
580700201 NICKEL PLATED

Pushbuttons: 8020, 8060, E010 & TP Series

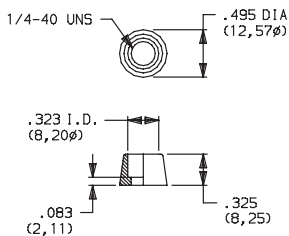

PART NO.
702501201 NICKEL PLATED
702501A56 BLACK

Toggles: 7000, 9000, E & T Series
 Pushbuttons: 8020, 8060, 8500, E010 & TP Series

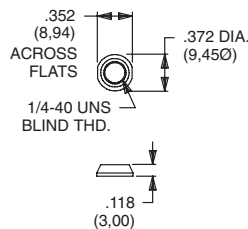

PART NO.
709901201 NICKEL PLATED
709901215 SATIN CHROME
709901A56 BLACK

Toggles: 7000, 9000, E & T Series
 Pushbuttons: 8020, 8060, 8500, E010 & TP Series

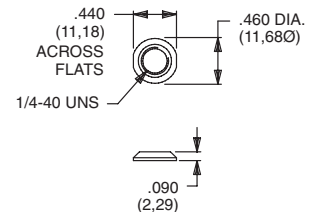

PART NO.
776001201 NICKEL PLATED
776002231 BLACK

Toggles: 7000, 9000, E & T Series
 Pushbuttons: 8020, 8060, 8500, E010 & TP Series

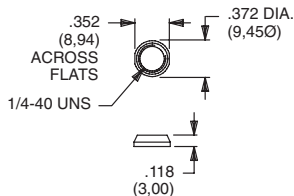

PART NO.
299D01201 NICKEL PLATED
299D01215 SATIN CHROME
299D01A56 BLACK

Pushbuttons: 8500 Series

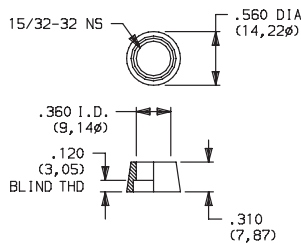

PART NO.
498800201 NICKEL PLATED

Toggles: 7000 Series, T2P Actuator

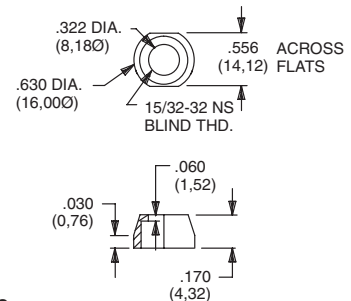

PART NO.
605300201 NICKEL PLATED

Toggles: 7000 & 9000 Series
 Pushbuttons: 8500 Series

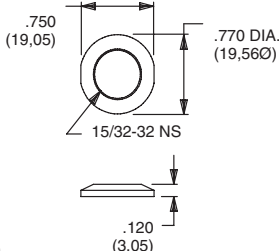

PART NO.
895101201 NICKEL PLATED
895101A56 BLACK

Toggles: 7000 Series
 Pushbuttons: 8020 & 8060 Series

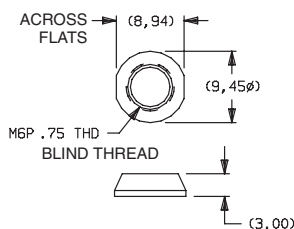

PART NO.
709903201 NICKEL PLATED
709903A56 BLACK

MATERIAL

Brass, nickel plated standard. Other finishes available, consult Customer Service center.

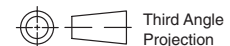

Third Angle Projection

Additional Hardware Information



N

KNURLED NUTS

Toggles: 7000, 9000 & T Series
Pushbuttons: 8020, 8060, 8500 & TP Series

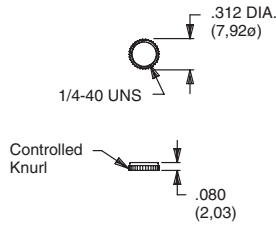

PART NO.
778000201 NICKEL PLATED
778000A56 BLACK

Toggles: 7000, 9000, E & T Series
Pushbuttons: 8020, 8060, 8500, E010 & TP Series

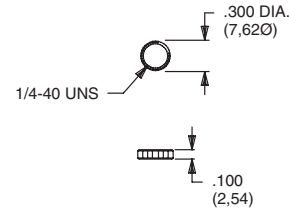

PART NO.
778600201 NICKEL PLATED
778600A56 BLACK

Toggles: 7000, 9000 & T Series
Pushbuttons: 8020, 8060, 8500 & TP Series
Fits Gulmite #12 Socket & Wrench 8942-02-201

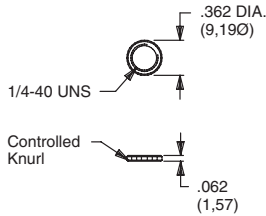

PART NO.
796901201 NICKEL PLATED
796901A56 BLACK

Toggles: 7000 & 9000 Series
Pushbuttons: 8500 Series
Will not fit T, T1, TP & T1P Toggles

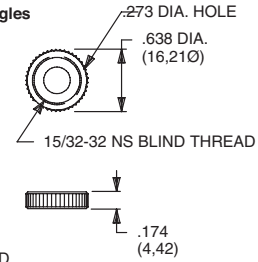

PART NO.
471300201 NICKEL PLATED
471300A56 BLACK

Toggles: 7000 Series
Pushbuttons: 8020 & 8060 Series

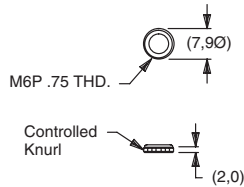

PART NO.
483200201 NICKEL PLATED

MATERIAL

Brass, nickel plated standard. Other finishes available, consult Customer Service center.

LOCKING RINGS

Toggles: T Series
Pushbuttons: TP Series
Fits 10-48 Bushing

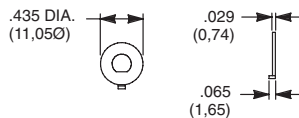

PART NO.
465000201 NICKEL PLATED WITH FLAT

Toggles: 7000, 9000 & T Series
Pushbuttons: 8020, 8060, 8500 & TP Series
Rotary: M Series
Fits 1/4-40 Bushing

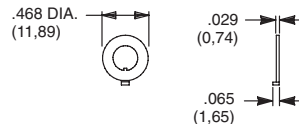

PART NO.
700701201 NICKEL PLATED WITH KEYWAY
700701A56 BLACK WITH KEYWAY

PANEL MOUNT ASSEMBLY

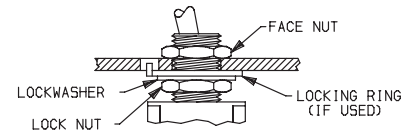

TYPICAL ASSEMBLY WITH LOCKING RING

NOTE: We recommend that locknut always be used with non-flanged bushings.

CAUTION: To avoid damaging panel front, always tighten locknut at back of panel. Overtightening mounting nut may cause K2-K12 actuators to bind.

MATERIAL

Brass, nickel plated standard. Other finishes available, consult Customer Service Center.



Hardware

LOCKING RINGS

Toggles: T Series
Pushbuttons: TP Series
Fits 10-48 Bushing

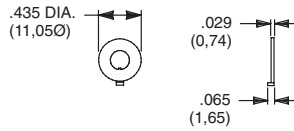

PART NO.

465101201 NICKEL PLATED WITH KEYWAY

Toggles: 7000, 9000 & T Series
Pushbuttons: 8020, 8060, 8500 & TP Series
Rotary: M Series
Fits 1/4-40 Bushing

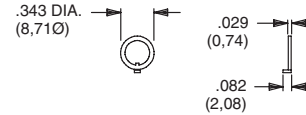

PART NO.

753700201 NICKEL PLATED WITH KEYWAY
753700A56 BLACK WITH KEYWAY

Toggles: 7000 & 9000 Series
Pushbuttons: 8500 Series
Fits 15/32 Bushing

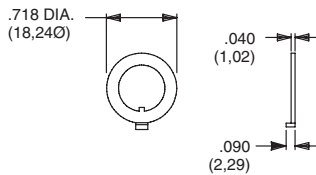

PART NO.

707200201 NICKEL PLATED WITH KEYWAY
707200A56 BLACK WITH KEYWAY

Toggles: 7000, 9000 & T Series
Pushbuttons: 8020, 8060, 8500 & TP Series
Rotary: M Series
Fits 1/4-40 Bushing

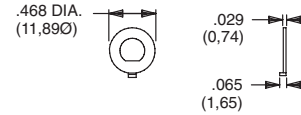

PART NO.

757200201 NICKEL PLATED WITH FLAT
757200A56 BLACK WITH FLAT

Toggles: 7000 Series
Pushbuttons: 8020 & 8060 Series
Fits M6P2 Metric Bushing

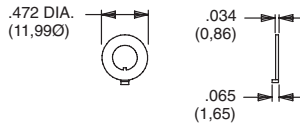

PART NO.

791800201 NICKEL PLATED WITH KEYWAY
791800A56 BLACK WITH KEYWAY

Toggles: 7000, 9000 & T Series
Pushbuttons: 8020, 8060, 8500 & TP Series
Rotary: M Series
Fits 1/4-40 Bushing

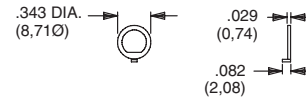

PART NO.

757300201 NICKEL PLATED WITH FLAT
757300A56 BLACK WITH FLAT

MATERIAL

Brass, nickel plated standard. Other finishes available, consult Customer Service Center.

LOCKWASHERS

Toggles: T Series
Pushbuttons: TP Series
Fits 10-48 Bushing

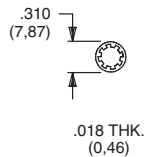

PART NO.

465200202 NICKEL PLATED

Toggles: 7000 & 9000 Series
Pushbuttons: 8500 Series
Fits 15/32 Bushing

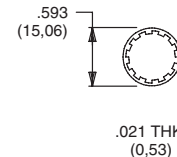

PART NO.

700302202 NICKEL PLATED
700302A56 BLACK

MATERIAL

Steel, nickel plated standard. Other finishes available, consult Customer Service Center.



Third Angle
Projection

Dimensions are shown: Inch (mm)
Specifications and dimensions subject to change



LOCKWASHERS

Toggles: 7000, 9000, E & T Series
Pushbuttons: 8020, 8060, 8500, E010 & TP Series
Fits 1/4-40 Bushing

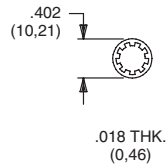

PART NO.

700303202 NICKEL PLATED
700303A56 BLACK

Switchlocks: A, BY, H, W, Y & YL Series
Fits 3/4 Dia. Bushing

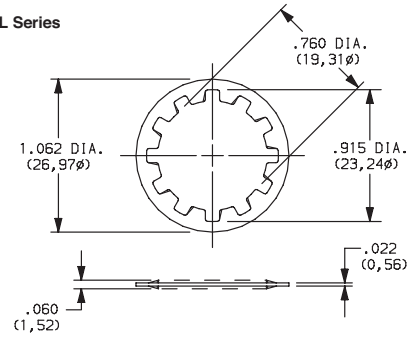

PART NO.

175050200 ZINC PLATED

Rotary: A & RTA Series
Fits 3/8 Dia. Thread
M10 X .75 metric

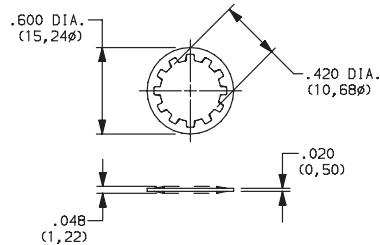

PART NO.

472800202

NICKEL PLATED

Pushbutton: 8700 Series
Rotary: F Series
Fits 5/16 Dia. Thread

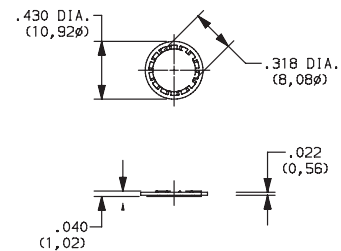

PART NO.

135A00000

ZIINC PLATED

MATERIAL

Steel, nickel plated standard. Other finishes available, consult Customer Service Center.

MOUNTING NUTS

Pushbuttons: 8600 Series

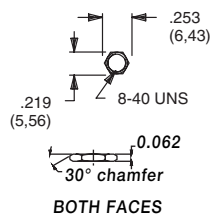

PART NO.

775200201 NICKEL PLATED
775200A56 BLACK

Toggles: T Series
Pushbuttons: TP Series

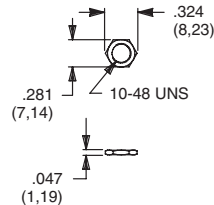

PART NO.

464900201 NICKEL PLATED
464900A56 BLACK

Rotary: M Series

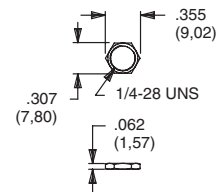

PART NO.

477100201 NICKEL PLATED

Toggles: E Series
Pushbuttons: E010 Series

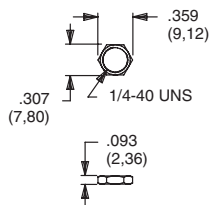

PART NO.

540400201 NICKEL PLATED
540400A56 BLACK

Toggles: 7000, 9000 & T Series
Pushbuttons: 8020, 8060, 8500 & TP Series

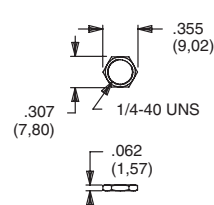

PART NO.

700201201 NICKEL PLATED
700201A56 BLACK

Toggles: 7000 & 9000 Series
Pushbuttons: 8500 Series

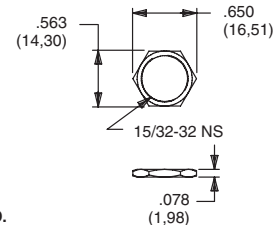

PART NO.

707100201 NICKEL PLATED
707100215 SATIN CHROME
707100A56 BLACK

MATERIAL

Brass, nickel plated standard. Other finishes available, consult Customer Service Center.



Additional Hardware Information



N

Hardware

MOUNTING NUTS

Toggles: 7000 Series
Pushbuttons: 8020 & 8060 Series

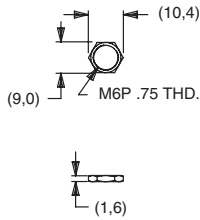

PART NO.
791600201 NICKEL PLATED
791600A56 BLACK

Switchlocks: A, BY, H, P, W, Y & YL Series

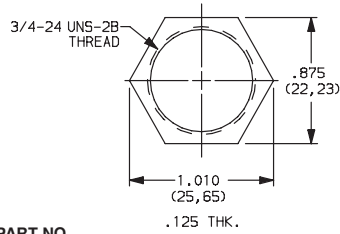

PART NO.
937C00000
ZINC PLATE

Rotary: A & RTA Series

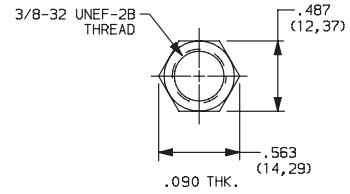

PART NO.
472706201
NICKEL PLATED

Rotary: A & RTA Series

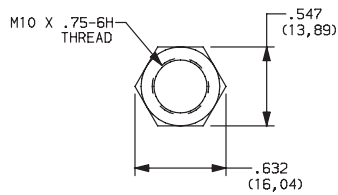

PART NO.
495100201
NICKEL PLATED

Rotary: H & R Series

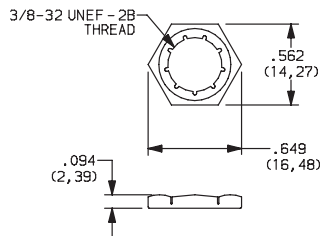

PART NO.
925C00000
ZINC, YELLOW TRIVALENT CHROMIUM

Rotary: F Series

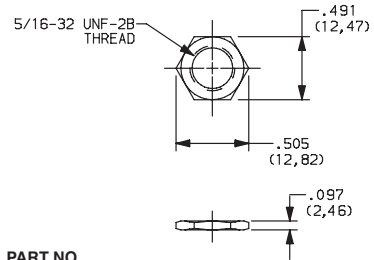

PART NO.
175020201
NICKEL PLATED

Switchlocks: YM Series

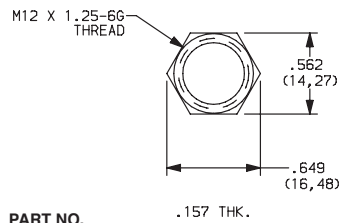

PART NO.
1790901A47
ZINC PLATED, CLEAR TRIVALENT CHROMIUM

Pushbutton: 8700 Series

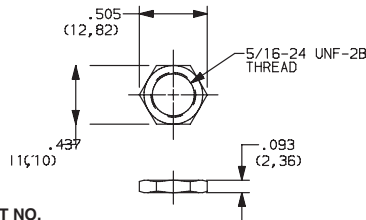

PART NO.
281B00201
NICKEL PLATED

MATERIAL

Brass, nickel plated standard. Other finishes available, consult Customer Service Center.

Additional Hardware Information



N



Third Angle Projection